

GUÍA DE CÓDIGOS TERMOPLÁSTICOS SISTEMAS DE TUBERÍA

SIMONA



EMMSA

Sistemas de Tubería

Pág. PP-H (Polipropileno Alpha Plus)

- 2** ▶ Tubería de PP-H (Polipropileno Alpha Plus)
- 4** ▶ Conexión de PP-H (Polipropileno Alpha Plus) Soldadura a Tope (Butt)
 - * RD-11 (Extremos Largos, Extremos Cortos y Accesorios)
 - * RD-17.6 (Extremos Largos, Extremos Cortos y Accesorios)
 - * RD-33 (Extremos Largos, Extremos Cortos y Accesorios)
 - * Accesorios (Bridas, Empaques y Soportes de Tubería)
- 22** ▶ Conexión de PP-H (Polipropileno Alpha Plus) Soldadura a Caja (Socket)
 - * RD-11
- 23** ▶ Tubería y Conexión de PP-H (Polipropileno Alpha Plus) para Ventilación: PPs
- 26** ▶ Válvulas
 - * Bola, 3 Vías, Esfera, Puerto
 - * Mariposa Operador Palanca, Engrane y Tipo Lug
 - * Diafragma Manual y Neumático
 - * Check Bola, Columpio y Wafer
 - * Globo y Globo de Control
 - * Válvulas de Indicador de Nivel
 - * Aguja
 - * Conectores de Tanque
 - * Protector de Manómetro (Sello Químico)
- 38** ▶ Reguladores de Presión
- 39** ▶ Válvulas de Alivio de Presión
- 40** ▶ Strainers, Filtros Yee, Canasta y Bolsa
- 44** ▶ Equipos de Termofusión

Pág. E-CTFE (HALAR) / PVDF (KYNAR)

- 46** ▶ Tubería de E-CTFE (HALAR)
- 47** ▶ Tubería de PVDF (KYNAR)
- 48** ▶ Conexión de PVDF (KYNAR) Soldadura a Tope (Butt)
 - * RD-21
 - * RD-33
 - * Accesorios (Aro para Bridas, Empaques y Soporte de Tubería)
- 55** ▶ Conexión de PVDF (KYNAR) Soldadura a Caja (Socket)
 - * RD-21
- 56** ▶ Válvulas
 - * Bola y 3 Vías
 - * Mariposa Operador Palanca, Engrane y Tipo Lug
 - * Diafragma Manual y Neumático
 - * Check Bola, Columpio y Wafer
 - * Globo y Globo de Control
 - * Protector de Manómetro (Sello Químico)
- 65** ▶ Reguladores de Presión
- 66** ▶ Filtros Bolsa
- 67** ▶ Equipos de Termofusión

Pág. PE-100 (Polietileno)

- 69** ▶ Tubería de PE-100
- 73** ▶ Conexión de PE-100 Soldadura a Tope (Butt)
 - * RD-11 (Extremos Largos, Extremos Cortos y Accesorios)
 - * RD-17 / 17.6 (Extremos Largos, Extremos Cortos y Accesorios)
 - * RD-33 (Extremos Largos, Extremos Cortos y Accesorios)
 - * Accesorios (Bridas, Empaques y Soportes de Tubería)
- 102** ▶ Equipos de Termofusión

PP-H (*Polipropileno Alpha Plus*)

Pág.	PP-H (<i>Polipropileno Alpha Plus</i>)
2	▶ Tubería de PP-H (Polipropileno Alpha Plus)
4	▶ Conexión de PP-H (Polipropileno Alpha Plus) Soldadura a Tope (Butt) * RD-11 (<i>Extremos Largos, Extremos Cortos y Accesorios</i>) * RD-17.6 (<i>Extremos Largos, Extremos Cortos y Accesorios</i>) * RD-33 (<i>Extremos Largos, Extremos Cortos y Accesorios</i>) * Accesorios (<i>Bridas, Empaques y Soportes de Tubería</i>)
22	▶ Conexión de PP-H (Polipropileno Alpha Plus) Soldadura a Caja (Socket) * RD-11
23	▶ Tubería y Conexión de PP-H (Polipropileno Alpha Plus) para Ventilación: PPs
26	▶ Válvulas * Bola, 3 Vías, Esfera, Puerto * Mariposa Operador Palanca, Engrane y Tipo Lug * Diafragma Manual y Neumático * Check Bola, Columpio y Wafer * Globo y Globo de Control * Válvulas de Indicador de Nivel * Aguja * Conectores de Tanque * Protector de Manómetro (<i>Sello Químico</i>)
38	▶ Reguladores de Presión
39	▶ Válvulas de Alivio de Presión
40	▶ Strainers, Filtros Yee, Canasta y Bolsa
44	▶ Equipos de Termofusión

TRAMOS DE 5 MTS

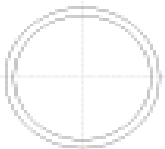

DIAM. (mm)	DIAM. APROX.
16	3/8"
20	1/2"
25	3/4"
32	1"
40	1 1/4"
50	1 1/2"
63	2"
75	2 1/2"
90	3"
110	4"
160	6"
200	8"
225	9"
250	10"
315	12"
355	14"
400	16"

CORRELACION RD Y PRESION NOMINAL (PN)

RD	PN (BAR)	PSI (lb/in2)
11	12.50	181.00
17.6	7.50	108.00
26	5.00	72.00
33	3.90	56.00
41	3.10	45.00

NOTAS:
 1.- FACTOR DE SEGURIDAD 1.6
 2.- VALORES REFERIDOS A 20°C Y VIDA UTIL DE 50 AÑOS, PARA CONEXION INYECTADA.

TUBERIA PP-H ALPHA PLUS, COLOR GRIS, RD 11



CÓDIGO	MEDIDA	PRECIO
010000716	10 mm	
010000717	12 mm	
010002883	16 mm	
010000720	20 mm	
010000722	25 mm	
010000724	32 mm	
010000726	40 mm	
010000730	50 mm	
010000733	63 mm	
010000736	75 mm	
010000740	90 mm	
010000745	110 mm	
010000749	125 mm	
010000752	140 mm	
010000757	160 mm	
010000760	180 mm	
010000765	200 mm	
010000768	225 mm	
010000772	250 mm	
010000775	280 mm	
010000780	315 mm	
010000784	355 mm	
010000789	400 mm	
010003083	450 mm	
010000796	500 mm	

**CÓDIGO
DESCUENTO**

TUBERIA PP-H ALPHA PLUS, COLOR GRIS, RD 17.6



CÓDIGO	MEDIDA	PRECIO
010000721	25 mm	
010000723	32 mm	
010000725	40 mm	
010000728	50 mm	
010000732	63 mm	
010000735	75 mm	
010000739	90 mm	
010000744	110 mm	
010000748	125 mm	
010000751	140 mm	
010000756	160 mm	
010000759	180 mm	
010000764	200 mm	
010000767	225 mm	
010000771	250 mm	
010000774	280 mm	
010000779	315 mm	
010000783	355 mm	
010000788	400 mm	
010003082	450 mm	
010000795	500 mm	
010000798	560mm	
010000799	630mm	
010000800	710mm	
010000801	800mm	

**CÓDIGO
DESCUENTO**

TUBERIA PP-H ALPHA PLUS, COLOR GRIS, RD 26



CÓDIGO	MEDIDA	PRECIO
010001197	40 mm	
010001198	50 mm	
010001200	63 mm	
010001202	75 mm	
010000738	90 mm	
010000743	110 mm	
010000747	125 mm	
010001206	140 mm	
010000755	160 mm	
010001208	180 mm	
010000763	200 mm	
010001210	225 mm	
010001211	250 mm	
010001213	280 mm	
010000778	315 mm	
010001214	355 mm	
010001215	400 mm	
010001218	450 mm	
010001219	500 mm	
010001221	560mm	
010001224	630mm	
010001227	710mm	
010001230	800mm	
010001233	900mm	
010001236	1000mm	

TUBERIA PP-H ALPHA PLUS, COLOR GRIS, RD 33



CÓDIGO	MEDIDA	PRECIO
010000727	50 mm	
010001199	63 mm	
010001201	75 mm	
010001203	90 mm	
010000742	110 mm	
010001204	125 mm	
010001205	140 mm	
010000754	160 mm	
010001207	180 mm	
010000762	200 mm	
010001209	225 mm	
010000770	250 mm	
010001212	280 mm	
010000777	315 mm	
010000782	355 mm	
010000787	400 mm	
010001217	450 mm	
010000794	500 mm	
010001220	560mm	
010001223	630mm	
010001226	710mm	
010001229	800mm	
010001232	900mm	
010001235	1000mm	

TUBERIA PP-H ALPHA PLUS, COLOR GRIS, RD 41



CÓDIGO	MEDIDA	PRECIO
010000731	63 mm	
010000734	75 mm	
010000737	90 mm	
010000741	110 mm	
010000746	125 mm	
010000750	140 mm	
010000753	160 mm	
010000758	180 mm	
010000761	200 mm	
010000766	225 mm	
010000769	250 mm	
010000773	280 mm	
010000776	315 mm	
010000781	355 mm	
010000786	400 mm	
010001216	450 mm	
010000793	500 mm	
010000797	560mm	
010001222	630mm	
010001225	710mm	
010001228	800mm	
010001231	900mm	
010001234	1000mm	

COMPENSADOR PP

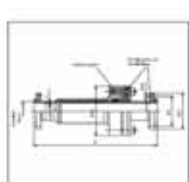

CÓDIGO	MEDIDA	PRECIO
015200003	63 mm	
015200004	75 mm	
015200005	90 mm	
015200001	110 mm	
015200006	125 mm	
015200007	140 mm	
015200008	160mm	
015200009	180 mm	
015200010	200mm	
015200002	215 mm	
015200011	250mm	
015200012	280mm	
015200013	315mm	
015200014	355mm	
015200015	400mm	

COPLE ELECTROSOLDABLE PP-H RD 11



CODIGO	MEDIDA	PRECIO
014300072	20 mm	
014300073	25 mm	
014300074	32 mm	
014300075	40 mm	
014300076	50 mm	
014300077	63 mm	
014300078	75 mm	
014300066	90 mm	
014300079	110 mm	
014300121	125 mm	
014300082	140 mm	
014300080	160 mm	
014300122	180 mm	
014300123	200 mm	
014300124	225 mm	

CÓDIGO
DESCUENTO

CODO 90° SIN COSTURA PP-H, EXT LARGOS RD 11



CÓDIGO	MEDIDA	PRECIO
010100410	32 mm	
010100411	40 mm	
010100412	50 mm	
010100413	63 mm	
010100414	75 mm	
010100416	90 mm	
010100418	110 mm	
010100419	125 mm	
010100420	140 mm	
010100422	160 mm	
010100424	180 mm	
010101092	200 mm	
010100425	225 mm	
010101095	250 mm	
010101097	280 mm	
010101099	315 mm	

CÓDIGO
DESCUENTO

CODO 90° PP-H, EXT LARGOS, RD 11



CÓDIGO	MEDIDA	PRECIO
019200074	20 mm	
019200075	25 mm	
019200076	32 mm	
019200077	40 mm	
019200078	50 mm	
019200079	63 mm	
019200080	75 mm	
019200081	90 mm	
019200082	110 mm	
019200136	125 mm	
019200379	140 mm	
019200138	160 mm	
019200140	180 mm	
019200142	200 mm	
019200144	225 mm	
019200302	250 mm	
019200304	280 mm	
019200306	315 mm	

CÓDIGO
DESCUENTO

CODO 90° FABRICADO PP-H, EXT LARGOS RD 11



CÓDIGO	MEDIDA	PRECIO
010100829	90 mm	
010100830	110 mm	
010100831	125 mm	
010100832	140 mm	
010100834	160 mm	
010100836	180 mm	
010100838	200 mm	
010100840	225 mm	
010100842	250 mm	
010100844	280 mm	
010100846	315 mm	
010100848	355mm	
010100850	400mm	
010100104	450mm	
010100852	500mm	

CÓDIGO
DESCUENTO

CODO 90° RADIO LARGO PP-H, EXT LARGOS RD 11



CÓDIGO	MEDIDA	PRECIO
019100134	20 mm	
019100135	25 mm	
019100136	32 mm	
019100137	40 mm	
019100139	50 mm	
019100034	63 mm	
019100036	75 mm	
019100038	90 mm	
019100040	110 mm	
019100061	125 mm	
019100062	140 mm	
019100063	160 mm	
019100064	180 mm	
019100065	200 mm	
019100042	225 mm	
019100098	250 mm	
019100100	280 mm	
019100102	315 mm	

CÓDIGO
DESCUENTO

CODO 45° PP-H, EXT LARGOS, RD 11



CÓDIGO	MEDIDA	PRECIO
019200083	20 mm	
019200084	25 mm	
019200085	32 mm	
019200086	40 mm	
019200087	50 mm	
019200089	63 mm	
019200090	75 mm	
019200092	90 mm	
019200094	110 mm	
019200095	125 mm	
019200385	140 mm	
019200097	160 mm	
019200149	180 mm	
019200151	200 mm	
019200098	225 mm	
019200296	250 mm	
019200298	280 mm	
019200300	315 mm	

CÓDIGO
DESCUENTO

CODO 45° FABRICADO PP-H, EXT LARGOS RD 11

CÓDIGO
DESCUENTO



CÓDIGO	MEDIDA	PRECIO
010100936	90 mm	
010100940	110 mm	
010100944	125 mm	
010100948	140 mm	
010100952	160 mm	
010100956	180 mm	
010100960	200 mm	
010100964	225 mm	
010100968	250 mm	
010100972	280 mm	
010100976	315 mm	
010100980	355mm	
010100984	400mm	
010100988	450mm	
010100992	500mm	

CODO 45° SIN COSTURA PP-H, EXT LARGOS RD 11

CÓDIGO
DESCUENTO



CÓDIGO	MEDIDA	PRECIO
010100399	32 mm	
010101130	40 mm	
010100400	50 mm	
010100401	63 mm	
010100402	75 mm	
010100403	90 mm	
010100405	110 mm	
010100406	125 mm	
010100407	140 mm	
010100408	160 mm	
010101139	180 mm	
010101141	200 mm	
010100409	225 mm	
010101144	250 mm	
010101146	280 mm	
010101148	315 mm	

CODO 60° FABRICADO PP-H, EXT LARGOS RD 11

CÓDIGO
DESCUENTO



CÓDIGO	MEDIDA	PRECIO
010100860	90 mm	
010100864	110 mm	
010100868	125 mm	
010100872	140 mm	
010100876	160 mm	
010100880	180 mm	
010100884	200 mm	
010100888	225 mm	
010100892	250 mm	
010100896	280 mm	
010100900	315 mm	
010100904	355mm	
010100908	400mm	
010100912	450mm	
010100916	500mm	

CODO 60° SIN COSTURA PP-H, EXT LARGOS RD 11

CÓDIGO
DESCUENTO



CÓDIGO	MEDIDA	PRECIO
010101100	32 mm	
010101101	40 mm	
010101103	50 mm	
010101105	63 mm	
010101107	75 mm	
010101109	90 mm	
010101111	110 mm	
010101113	125 mm	
010101115	140 mm	
010101117	160 mm	
010101119	180 mm	
010101121	200 mm	
010101123	225 mm	
010101125	250 mm	
010101127	280 mm	
010101129	315 mm	

CODO 30° SIN COSTURA PP-H, EXT LARGOS RD 11

CÓDIGO
DESCUENTO



CÓDIGO	MEDIDA	PRECIO
010101149	32 mm	
010101150	40 mm	
010101152	50 mm	
010101154	63 mm	
010101156	75 mm	
010101158	90 mm	
010101160	110 mm	
010101162	125 mm	
010101164	140 mm	
010101166	160 mm	
010101168	180 mm	
010101170	200 mm	
010101172	225 mm	
010101174	250 mm	
010101176	280 mm	
010101178	315 mm	

CODO 30° FABRICADO PP-H, EXT LARGOS RD 11

CÓDIGO
DESCUENTO



CÓDIGO	MEDIDA	PRECIO
010101012	90 mm	
010101017	110 mm	
010101021	125 mm	
010101025	140 mm	
010101029	160 mm	
010101033	180 mm	
010101037	200 mm	
010101041	225 mm	
010101045	250 mm	
010101049	280 mm	
010101053	315 mm	
010101057	355mm	
010101061	400mm	
010101065	450mm	
010101069	500mm	

STUB END PP-H (PORTABRIDA) ANSI, EXT LARGOS RD 11



CÓDIGO	MEDIDA	PRECIO
019400386	20 mm	
019400387	25 mm	
010600687	32 mm	
010600688	40 mm	
010600689	50 mm	
010600691	63 mm	
019400323	75 mm	
019400324	90 mm	

STUB END PP-H (PORTABRIDA) ISO/DIN, EXT LARGOS, RD 11



CÓDIGO	MEDIDA	PRECIO
019400085	20 mm	
019400086	25 mm	
019400247	32 mm	
019400248	40 mm	
019400249	50 mm	
019400250	63 mm	
019400092	75 mm	
019400093	90 mm	
019400094	110 mm	
019400096	125 mm	
019400180	140 mm	
019400098	160 mm	
019400100	180 mm	
019400102	200 mm	
019400104	225 mm	
019400197	250 mm	
019400243	280 mm	
019400201	315 mm	

TEE PP-H, EXT LARGOS RD 11



CÓDIGO	MEDIDA	PRECIO
019300095	20 mm	
019300094	25 mm	
019300083	32 mm	
019300064	40 mm	
019300099	50 mm	
019300100	63 mm	
019300101	75 mm	
019300022	90 mm	
019300023	110 mm	
019300024	125 mm	
019300025	140 mm	
019300026	160 mm	
019300027	180 mm	
019300028	200 mm	
019300029	225 mm	
019300047	250 mm	
019300045	280 mm	
019300048	315 mm	
019300213	355mm	
019300214	400mm	
019300210	450mm	
019300212	500mm	

TEE FABRICADA PP-H, EXT LARGOS RD 11



CODIGO	MEDIDA	PRECIO
010300427	90 mm	
010300431	110 mm	
010300435	125 mm	
010300439	140 mm	
010300443	160 mm	
010300447	180 mm	
010300451	200 mm	
010300455	225 mm	
010300459	250 mm	
010300463	280 mm	
010300467	315 mm	
010300471	355mm	
010300475	400mm	
010300241	450mm	
010300242	500mm	

TEE REDUCIDA PP-H, EXT LARGOS RD 11



CODIGO	MEDIDA	PRECIO
013500143	63x50 mm	
013500144	75x63 mm	
013500330	75x32 mm	
013500331	75x50 mm	
013500145	90x75 mm	
013500577	90x50 mm	
013500578	90x63 mm	
013500146	110x75 mm	
013500332	110x63 mm	
013500333	110x90 mm	
013500334	125x110 mm	
013500147	160x63 mm	
013500579	160x90 mm	
013500580	160x110 mm	
013500335	160x75 mm	
013500336	180x160 mm	
013500148	225x90 mm	
013500338	225x75 mm	
013500339	225x180 mm	
013500581	225x110 mm	
013500582	225x160 mm	
022300164	250x110 mm	
022300165	250x160 mm	
022300166	315x110 mm	
022300167	315x160 mm	
022300168	225x160 mm	
022300161	200x63 mm	
022300162	200x90 mm	
022300163	200x110 mm	
013500337	200x160 mm	

TEES REDUCIDAS, SEMIMONTADAS, ABOCARDADAS, RD 11



CODIGO	MEDIDA	PRECIO
013500601	90x50 mm	
013500603	110x50 mm	
013500604	110x63 mm	
013500607	125x63 mm	
013500606	125x50 mm	
013500608	125x75 mm	
013500612	140x90 mm	
013500611	140x75 mm	
013500610	140x63 mm	
013500616	160x90 mm	
013500615	160x75 mm	
013500617	160x110 mm	
013500614	160x63 mm	
013500618	180x75 mm	
013500620	180x110 mm	
013500619	180x90 mm	
013500624	200x110 mm	
013500623	200x90 mm	
013500622	200x75 mm	
013500625	200x140 mm	
013500627	225x75 mm	
013500630	225x140 mm	
013500629	225x110 mm	
013500628	225x90 mm	
013500631	225x160 mm	
013500633	250x90 mm	
013500636	250x160 mm	
013500635	250x140 mm	
013500634	250x110 mm	
013500637	250x180 mm	
013500642	280x160 mm	
013500639	280x90 mm	
013500641	280x140 mm	
013500644	280x200 mm	
013500643	280x180 mm	
013500640	280x110 mm	
013500651	315x225 mm	
013500650	315x200 mm	
013500647	315x140 mm	
013500649	315x180 mm	
013500646	315x110 mm	
013500648	315x160 mm	
013500654	355x140 mm	
013500656	355x180 mm	
013500653	355x110 mm	
013500659	355x250 mm	
013500658	355x225 mm	
013500655	355x160 mm	
013500657	355x200 mm	
013500666	400x250 mm	
013500662	400x160 mm	
013500664	400x200 mm	
013500665	400x225 mm	
013500661	400x140 mm	
013500663	400x180 mm	
013500667	400x280 mm	
013500671	450x200 mm	
013500674	450x280 mm	
013500668	450x140 mm	
013500673	450x250 mm	

TEES REDUCIDAS, SEMIMONTADAS, ABOCARDADAS, RD 11



CODIGO	MEDIDA	PRECIO
013500670	450x180 mm	
013500672	450x225 mm	
013500675	450x215 mm	
013500669	450x160 mm	
013500680	500x250 mm	
013500683	500x355 mm	
013500677	500x180 mm	
013500679	500x225 mm	
013500676	500x160 mm	
013500682	500x315 mm	
013500681	500x280 mm	
013500678	500x200 mm	

YEE 60° FABRICADA PP-H, EXT LARGOS RD 11



CODIGO	MEDIDA	PRECIO
013700099	110mm	
013700101	125mm	
013700103	140mm	
013700105	160mm	
013700107	180mm	
013700109	200 mm	
013700111	225 mm	
013700055	250 mm	
013700057	280 mm	
013700059	315 mm	
013700061	355mm	
013700063	400mm	
013700065	450mm	
013700067	500mm	

YEE 45° FABRICADA PP-H, EXT LARGOS RD 11



CODIGO	MEDIDA	PRECIO
013700026	110mm	
013700123	125mm	
013700127	140mm	
013700132	160mm	
013700136	180mm	
013700140	200 mm	
013700144	225 mm	
013700147	250 mm	
013700149	280 mm	
013700151	315 mm	
013700153	355mm	
013700155	400mm	
013700157	450mm	
013700159	500mm	

YEE 45° PP-H, EXT LARGOS RD 11



CODIGO	MEDIDA	PRECIO
013700654	63 mm	
013700655	75 mm	
013700656	90 mm	
013700657	110 mm	

REDUCCION EXCENTRICA PP-H, EXT LARGOS RD 11

CODIGO
DESCUENTO



CODIGO	MEDIDA	PRECIO
015000289	25x20 mm	
015000290	32x20 mm	
015000292	32x25 mm	
015000291	40x25 mm	
015000294	50x40 mm	
015000293	50x32 mm	
015000180	63x50 mm	
015000179	63x40 mm	
015000295	63x32 mm	
015000296	75x50 mm	
015000181	75x63 mm	
015000182	90x63 mm	
015000183	90x75 mm	
015000185	110x63 mm	
015000186	110x90 mm	
015000297	125x63 mm	
015000187	125x90 mm	
015000188	125x110 mm	
015000189	140x125 mm	
015000298	160x90 mm	
015000190	160x110 mm	
015000299	160x125 mm	
015000191	160x140 mm	
015000300	180x90 mm	
015000301	180x125 mm	
015000302	180x160 mm	
015000303	200x160 mm	
015000304	200x180 mm	
015000192	225x160 mm	
015000305	225x180 mm	
015000306	225x200 mm	
015000193	250x225 mm	

REDUCCION CONCENTRICA PP-H, EXT LARGOS RD 11

CODIGO
DESCUENTO



CODIGO	MEDIDA	PRECIO
019700328	25x20 mm	
019700102	32x20 mm	
019700278	32x25 mm	
019700064	40x20 mm	
019700327	40x25 mm	
019700279	40x32 mm	
019700160	50x25 mm	
019700161	50x32 mm	
019700162	50x40 mm	
019700163	63x32 mm	
019700164	63x40 mm	
019700165	63x50 mm	
019700073	75x50 mm	
019700184	75x63 mm	
019700166	90x50 mm	
019700167	90x63 mm	
019700168	90x75 mm	
019700245	110x63 mm	
019700275	110x75 mm	
019700246	110x90 mm	
019700247	125x63 mm	
019700237	125x90 mm	
019700244	125x110 mm	
019700435	140x125 mm	
019700449	140x75 mm	
019700433	140x90 mm	
019700434	140x110 mm	
019700204	160x90 mm	
019700205	160x110 mm	
019700226	160x125 mm	
019700229	160x140 mm	
019700367	180x90 mm	
019700631	180x125 mm	
019700452	180x160 mm	
019700450	180x110 mm	
019700451	180x140 mm	
019700453	200x140 mm	
019700209	200x160 mm	
019700454	200x180 mm	
019700210	225x160 mm	
019700092	225x180 mm	
019700455	225x200 mm	
019700094	250x180 mm	
019700095	250x200 mm	
019700096	250x225 mm	
019700093	250x160 mm	
019700213	280x200 mm	
019700212	280x225 mm	
019700211	280x250 mm	
019700215	315x225 mm	
019700097	315x250 mm	
019700214	315x280 mm	

TAPON PP-H, EXT LARGOS RD 11

CODIGO
DESCUENTO



CODIGO	MEDIDA	PRECIO
019600135	20 mm	
019600113	25 mm	
013900093	32 mm	
019600034	40 mm	
019600030	50 mm	
019600037	63 mm	
019600031	75 mm	
019600039	90 mm	
019600032	110 mm	
019600041	125 mm	
019600043	140 mm	
019600051	160 mm	
019600045	180 mm	
019600026	200 mm	
019600048	225 mm	
019600064	250 mm	
019600078	280 mm	
019600068	315 mm	
019600137	355mm	
019600139	400mm	

ADAP HEMBRA ROSCA NPT, PP-H, EXT LARGOS RD 11



CODIGO	MEDIDA	PRECIO
018800007	20 X 1/2"	
018800008	25 X 3/4"	
018800009	32 X 1"	
018800010	40 X 1 1/4"	
018800011	50 X 1 1/2"	
018800012	63 X 2"	

CÓDIGO
DESCUENTO

TUERCA UNION PP-H/FPM, EXT LARGOS RD 11



CODIGO	MEDIDA	PRECIO
019500013	20 mm	
019500014	25 mm	
019500015	32 mm	
019500016	40 mm	
019500017	50 mm	
019500018	63 mm	

CÓDIGO
DESCUENTO

ADAP MACHO ROSCA NPT, PP-H, EXT LARGOS RD 11



CODIGO	MEDIDA	PRECIO
018900007	20 X 1/2"	
018900008	25 X 3/4"	
018900009	32 X 1"	
018900010	40 X 1 1/4"	
018900011	50 X 1 1/2"	
018900012	63 X 2"	

CÓDIGO
DESCUENTO

TUERCA UNION PP-H/EPDM, EXT LARGOS RD 11



CODIGO	MEDIDA	PRECIO
019500007	20 mm	
019500008	25 mm	
019500009	32 mm	
019500010	40 mm	
019500011	50 mm	
019500012	63 mm	

CÓDIGO
DESCUENTO

CODO 90° PP-H, RD 11



CÓDIGO	MEDIDA	PRECIO
010100426	20 mm	
010100427	25 mm	
010100428	32 mm	
010100429	40 mm	
010100431	50 mm	
010100433	63 mm	
010100435	75 mm	
010100437	90 mm	
010100440	110 mm	
010100442	125 mm	
010100444	140 mm	
010100447	160 mm	
010100449	180 mm	
010100452	200 mm	
010100454	225 mm	
010100386	250 mm	
010100389	280 mm	
010100392	315 mm	
010100395	355 mm	
010100398	400 mm	



STUB END PP-H (PORTABRIDA) ISO/DIN, RD 11



CÓDIGO	MEDIDA	PRECIO
010600222	20 mm	
010600223	25 mm	
010600224	32 mm	
010600225	40 mm	
010600226	50 mm	
010600227	63 mm	
010600172	75 mm	
010600174	90 mm	
010600177	110 mm	
010600179	125 mm	
010600182	140 mm	
010600185	160 mm	
010600187	180 mm	
010600190	200 mm	
010600193	225 mm	
010600196	250 mm	
010600199	280 mm	
010600202	315 mm	
010600205	355 mm	
010600208	400 mm	
010600210	450 mm	
010600212	500 mm	



STUB END PP-H (PORTABRIDA) ISO/DIN, FABRICADA RD 11



CÓDIGO	MEDIDA	PRECIO
010600459	560 mm	
010600460	630 mm	



STUB END PP-H (PORTABRIDA) ANSI, RD 11



CODIGO	MEDIDA	PRECIO
010600866	20 mm	
010600867	25 mm	
010600868	32 mm	
010600869	40 mm	
010600973	50 mm	
010600871	63 mm	
010600220	75 mm	
010600221	90 mm	



TEE PP-H, RD 11



CODIGO	MEDIDA	PRECIO
010300193	20 mm	
010300194	25 mm	
010300195	32 mm	
010300196	40 mm	
010300198	50 mm	
010300200	63 mm	
010300202	75 mm	
010300152	90 mm	
010300155	110 mm	
010300158	125 mm	
010300161	140 mm	
010300164	160 mm	
010300166	180 mm	
010300169	200 mm	
010300172	225 mm	
010300175	250 mm	
010300178	280 mm	
010300181	315 mm	
010300183	355 mm	
010300185	400 mm	
010300954	450 mm	
010300956	500 mm	



TEE REDUCIDA PP-H, RD 11



CODIGO	MEDIDA	PRECIO
013500126	90/32 mm	
013500128	110/32 mm	
013500129	125/63 mm	
013500304	110/50 mm	
013500130	125/90 mm	
013500131	140/63 mm	
013500132	140/90 mm	
013500309	140/75 mm	
013500310	140/110 mm	
013500314	160/125 mm	
013500134	180/63 mm	
013500315	180/75 mm	
013500316	180/110 mm	
013500318	200/63 mm	
013500319	200/90 mm	
013500320	200/110 mm	
013500321	200/125 mm	
013500322	200/160 mm	
013500135	250/160 mm	
013500329	250/110 mm	



REDUCCION CONCENTRICA PP-H, RD 11

CÓDIGO
DESCUENTO



CODIGO	MEDIDA	PRECIO
014900268	25/20 mm	
014900269	32/20 mm	
014900270	32/25 mm	
014900271	40/20 mm	
014900272	40/25 mm	
014900273	40/32 mm	
014900369	50/25 mm	
014900370	50/32 mm	
014900371	50/40 mm	
014900372	63/32 mm	
014900373	63/40 mm	
014900374	63/50 mm	
014900279	75/32 mm	
014900280	75/40 mm	
014900281	75/50 mm	
014901005	75/63 mm	
014900375	90/50 mm	
014900376	90/63 mm	
014900377	90/75 mm	
014900378	110/50 mm	
014900379	110/63 mm	
014900380	110/75 mm	
014900381	110/90 mm	
014900382	125/63 mm	
014900383	125/75 mm	
014900384	125/90 mm	
014900385	125/110 mm	
014901006	140/75 mm	
014901007	140/90 mm	
014901008	140/110 mm	
014901009	140/125 mm	
014900386	160/90 mm	
014900387	160/110 mm	
014900388	160/125 mm	
014900389	160/140 mm	
014901010	180/90 mm	
014901011	180/110 mm	
014901012	180/125 mm	
014901013	180/140 mm	
014901014	180/160 mm	
014900390	200/160 mm	
014901015	200/140 mm	
014901016	200/180 mm	
014900391	225/140 mm	
014900392	225/160 mm	
014900393	225/180 mm	
014901017	225/200 mm	
014900314	250/160 mm	
014900315	250/180 mm	
014900316	250/200 mm	
014900317	250/225 mm	
014900318	280/200 mm	
014900319	280/225 mm	
014900320	280/250 mm	
014900321	315/200 mm	
014900322	315/225 mm	
014900323	315/250 mm	
014900324	315/280 mm	

REDUCCION CONCENTRICA FABRICADA PP-H, RD 11

CÓDIGO
DESCUENTO



CODIGO	MEDIDA	PRECIO
014900325	355/225 mm	
014900326	355/250 mm	
014900327	355/280 mm	
014900328	355/315 mm	
014900607	400/225 mm	
014900608	400/250 mm	
014900609	400/280 mm	
014900329	400/315 mm	
014900610	400/355 mm	
014900611	450/280 mm	
014900612	450/315 mm	
014900330	450/355 mm	
014900613	450/400 mm	
014900615	500/315 mm	
014900331	500/355 mm	
014900332	500/400 mm	
014900616	500/450 mm	
014900618	560/400 mm	
014900619	560/450 mm	
014900620	560/500 mm	
014900622	630/400 mm	
014900623	630/450 mm	
014900624	630/500 mm	
014900625	630/560 mm	

TAPON FABRICADO PP-H, RD 11

CÓDIGO
DESCUENTO



CODIGO	MEDIDA	PRECIO
013900140	250 mm	
013900142	280 mm	
013900144	315 mm	
013900146	355 mm	
013900148	400 mm	
013900150	450 mm	
013900152	500 mm	

RESTRICTOR (PARA ABRAZADERA) PP-H, RD 11

CÓDIGO
DESCUENTO



CODIGO	MEDIDA	PRECIO
015400024	50 mm	
015400025	63 mm	
015400026	75 mm	
015400027	90 mm	
015400028	110 mm	
015400029	125 mm	
015400030	140 mm	
015400031	160 mm	
015400032	180 mm	
015400033	200 mm	
015400034	225 mm	
015400035	250 mm	
015400036	280 mm	
015400037	315 mm	
015400038	355 mm	
015400039	400 mm	
015400040	450 mm	
015400041	500 mm	

CODO 90° FABRICADO PP-H, EXT LARGOS RD 17.6



CÓDIGO	MEDIDA	PRECIO
010100825	90 mm	
010100826	110 mm	
010100827	125 mm	
010100828	140 mm	
010100833	160 mm	
010100835	180 mm	
010100837	200 mm	
010100839	225 mm	
010100841	250 mm	
010100843	280 mm	
010100845	315 mm	
010100847	355 mm	
010100849	400 mm	
010100103	450 mm	
010100851	500 mm	
010100853	560 mm	
010100854	630 mm	
010100855	710 mm	
010100856	800 mm	

CODO 90° PP-H RADIO LARGO, EXT LARGOS RD 17.6



CÓDIGO	MEDIDA	PRECIO
019100138	50 mm	
019100033	63 mm	
019100066	75 mm	
019100037	90 mm	
019100039	110 mm	
019100067	125 mm	
019100068	140 mm	
019100069	160 mm	
019100070	180 mm	
019100071	200 mm	
019100041	225 mm	
019100097	250 mm	
019100099	280 mm	
019100101	315 mm	

CODO 45° PP-H, EXT LARGOS RD 17.6



CÓDIGO	MEDIDA	PRECIO
019200145	50 mm	
019200088	63 mm	
019200146	75 mm	
019200091	90 mm	
019200093	110 mm	
019200147	125 mm	
019200382	140 mm	
019200096	160 mm	
019200148	180 mm	
019200150	200 mm	
019200152	225 mm	
019200295	250 mm	
019200297	280 mm	
019200299	315 mm	

CODO 45° FABRICADO PP-H, EXT LARGOS RD 17.6



CÓDIGO	MEDIDA	PRECIO
010100935	90 mm	
010100939	110 mm	
010100943	125 mm	
010100947	140 mm	
010100951	160 mm	
010100955	180 mm	
010100959	200 mm	
010100963	225 mm	
010100967	250 mm	
010100971	280 mm	
010100975	315 mm	
010100979	355 mm	
010100983	400 mm	
010100987	450 mm	
010100991	500 mm	
010100995	560 mm	
010100998	630 mm	
010101001	710 mm	
010101004	800 mm	

CODO 30° FABRICADO PP-H, EXT LARGOS RD 17.6



CÓDIGO	MEDIDA	PRECIO
010101011	90 mm	
010101016	110 mm	
010101020	125 mm	
010101024	140 mm	
010101028	160 mm	
010101032	180 mm	
010101036	200 mm	
010101040	225 mm	
010101044	250 mm	
010101048	280 mm	
010101052	315 mm	
010101056	355 mm	
010101060	400 mm	
010101064	450 mm	
010101068	500 mm	
010101072	560 mm	
010101075	630 mm	
010101078	710 mm	
010101081	800 mm	

CODO 60° FABRICADO PP-H, EXT LARGOS RD 17.6



CÓDIGO	MEDIDA	PRECIO
010100859	90 mm	
010100863	110 mm	
010100867	125 mm	
010100871	140 mm	
010100875	160 mm	
010100879	180 mm	
010100883	200 mm	
010100887	225 mm	
010100891	250 mm	
010100895	280 mm	
010100899	315 mm	
010100903	355 mm	
010100907	400 mm	
010100911	450 mm	
010100915	500 mm	
010100919	560 mm	
010100922	630 mm	
010100925	710 mm	
010100928	800 mm	

TEE FABRICADA PP-H, EXT LARGOS RD 17.6



CÓDIGO	MEDIDA	PRECIO
010300426	90 mm	
010300430	110 mm	
010300434	125 mm	
010300438	140 mm	
010300442	160 mm	
010300446	180 mm	
010300450	200 mm	
010300454	225 mm	
010300458	250 mm	
010300462	280 mm	
010300466	315 mm	
010300470	355 mm	
010300474	400 mm	
010300478	450 mm	
010300481	500 mm	
010300484	560 mm	
010300487	630 mm	
010300490	710 mm	
010300493	800 mm	

CÓDIGO
DESCUENTO

YEE 60° FABRICADA PP-H, EXT LARGOS RD 17.6



CÓDIGO	MEDIDA	PRECIO
013700098	110 mm	
013700100	125 mm	
013700102	140 mm	
013700104	160 mm	
013700106	180 mm	
013700108	200 mm	
013700110	225 mm	
013700054	250 mm	
013700056	280 mm	
013700058	315 mm	
013700060	355mm	
013700062	400mm	
013700064	450mm	
013700066	500 mm	
013700068	560 mm	
013700069	630 mm	

CÓDIGO
DESCUENTO

YEE 45° PP-H, EXT LARGOS RD 17.6



CÓDIGO	MEDIDA	PRECIO
013700658	63 mm	
013700659	75 mm	
013700660	90 mm	
013700661	110 mm	

CÓDIGO
DESCUENTO

TAPON PP-H, EXT LARGOS RD 17.6



CÓDIGO	MEDIDA	PRECIO
019600035	50 mm	
019600036	63 mm	
013900094	75 mm	
019600038	90 mm	
019600040	110 mm	
019600025	125 mm	
019600042	140 mm	
019600050	160 mm	
019600044	180 mm	
019600046	200 mm	
019600047	225 mm	
019600063	250 mm	
019600065	280 mm	
019600067	315 mm	
019600136	355 mm	
019600138	400 mm	

CÓDIGO
DESCUENTO

YEE 45° FABRICADA PP-H, EXT LARGOS RD 17.6



CÓDIGO	MEDIDA	PRECIO
013700117	110 mm	
013700121	125 mm	
013700126	140 mm	
013700130	160 mm	
013700134	180 mm	
013700138	200 mm	
013700142	225 mm	
013700146	250 mm	
013700148	280 mm	
013700150	315 mm	
013700152	355mm	
013700154	400mm	
013700156	450mm	
013700158	500 mm	
013700160	560 mm	
013700161	630 mm	

CÓDIGO
DESCUENTO

TEE REDUCIDA PP-H, EXT LARGOS RD 17.6



CÓDIGO	MEDIDA	PRECIO
013500570	90x50 mm	
013500571	90x63 mm	
013500457	110x63 mm	
013500459	110x90 mm	
013500573	160x90 mm	
013500572	160x110 mm	
013500142	225x180 mm	
013500464	225x75 mm	
013500574	225x90 mm	
013500575	225x110 mm	
013500576	225x160 mm	
022300156	250x110mm	
022300157	250x160 mm	
022300158	315x110 mm	
022300159	315x160 mm	
022300160	315x250 mm	

CÓDIGO
DESCUENTO

TEE REDUCIDA FABRICADA PP-H, EXT LARGOS RD 17.6



CÓDIGO	MEDIDA	PRECIO
013500340	90x50 mm	
013500341	110x50 mm	
013500342	110x63 mm	
013500344	125x50 mm	
013500345	125x63 mm	
013500346	125x75 mm	
013500348	140x63 mm	
013500349	140x75 mm	
013500584	140x90 mm	
013500587	160x110 mm	
013500350	160x63 mm	
013500351	160x75 mm	
013500586	160x90 mm	
013500589	180x110 mm	
013500352	180x75 mm	
013500588	180x90 mm	
013500591	200x110 mm	
013500355	200x140 mm	
013500354	200x75 mm	
013500590	200x90 mm	
013500593	225x110 mm	
013500358	225x140 mm	
013500359	225x160 mm	
013500360	225x180 mm	
013500357	225x75 mm	
013500592	225x90 mm	
013500595	250x110 mm	
013500361	250x140 mm	
013500362	250x160 mm	
013500363	250x180 mm	
013500112	250x200 mm	
013500594	250x90 mm	
013500597	280x110 mm	
013500364	280x140 mm	
013500365	280x160 mm	
013500366	280x180 mm	
013500367	280x200 mm	
013500368	280x225 mm	
013500596	280x90 mm	
013500598	315x110 mm	
013500369	315x140 mm	
013500113	315x160 mm	
013500370	315x180 mm	
013500371	315x200 mm	
013500372	315x225 mm	
013500373	315x250 mm	
013500600	355x110 mm	

TEE REDUCIDA FABRICADA PP-H, EXT LARGOS RD 17.6



CÓDIGO	MEDIDA	PRECIO
013500374	355x140 mm	
013500375	355x160 mm	
013500376	355x180 mm	
013500377	355x200 mm	
013500378	355x225 mm	
013500379	355x250 mm	
013500380	355x280 mm	
013500381	400x140 mm	
013500382	400x160 mm	
013500383	400x180 mm	
013500384	400x200 mm	
013500385	400x225 mm	
013500386	400x250 mm	
013500387	400x280 mm	
013500388	400x315 mm	
013500599	450x140 mm	
013500389	450x160 mm	
013500390	450x180 mm	
013500391	450x200 mm	
013500392	450x225 mm	
013500393	450x250 mm	
013500394	450x280 mm	
013500395	450x315 mm	
013500396	500x160 mm	
013500397	500x180 mm	
013500398	500x200 mm	
013500399	500x225 mm	
013500400	500x250 mm	
013500401	500x280 mm	
013500402	500x315 mm	
013500403	500x355 mm	
013500404	560x180 mm	
013500405	560x200 mm	
013500406	560x225 mm	
013500407	560x250 mm	
013500408	560x280 mm	
013500409	560x315 mm	
013500410	560x355 mm	
013500411	560x400 mm	
013500412	630x200 mm	
013500413	630x225 mm	
013500414	630x250 mm	
013500415	630x280 mm	
013500416	630x315 mm	
013500417	630x355 mm	
013500418	630x400 mm	
013500419	630x450 mm	

CODO 90° PP-H, RD 17.6



CÓDIGO	MEDIDA	PRECIO
010100430	50 mm	
010100432	63 mm	
010100434	75 mm	
010100436	90 mm	
010100439	110 mm	
010100441	125 mm	
010100443	140 mm	
010100446	160 mm	
010100448	180 mm	
010100451	200 mm	
010100453	225 mm	
010100385	250 mm	
010100388	280 mm	
010100391	315 mm	
010100394	355 mm	
010100397	400 mm	



STUB END PP-H (PORTABRIDA) ISO/DIN, RD 17.6



CÓDIGO	MEDIDA	PRECIO
010600413	50 mm	
010600414	63 mm	
010600171	75 mm	
010600173	90 mm	
010600176	110 mm	
010600178	125 mm	
010600181	140 mm	
010600184	160 mm	
010600186	180 mm	
010600189	200 mm	
010600192	225 mm	
010600195	250 mm	
010600198	280 mm	
010600201	315 mm	
010600204	355 mm	
010600207	400 mm	
010600209	450 mm	
010600211	500 mm	
010600213	560 mm	
010600214	630 mm	



STUB END PP-H (PORTABRIDA) ISO/DIN, FABRICADA RD 17.6



CÓDIGO	MEDIDA	PRECIO
010600369	710 mm	
010600371	800 mm	
010600457	900 mm	
010600458	1000 mm	



STUB END PP-H (PORTABRIDA) ANSI, RD 17.6



CODIGO	MEDIDA	PRECIO
010600872	50 mm	
010600873	63 mm	
010600645	75 mm	
010600646	90 mm	



TEE PP-H, RD 17.6



CODIGO	MEDIDA	PRECIO
010300197	50 mm	
010300199	63 mm	
010300201	75 mm	
010300151	90 mm	
010300154	110 mm	
010300157	125 mm	
010300160	140 mm	
010300163	160 mm	
010300165	180 mm	
010300168	200 mm	
010300171	225 mm	
010300174	250 mm	
010300177	280 mm	
010300180	315 mm	
010300182	355 mm	
010300184	400 mm	
010300953	450 mm	
010300955	500 mm	



TEE REDUCIDA PP-H, RD 17.6



CODIGO	MEDIDA	PRECIO
013500114	90/32 mm	
013500425	110/32 mm	
013500426	110/50 mm	
013500430	125/63 mm	
013500431	125/90 mm	
013500117	140/63 mm	
013500118	140/90 mm	
013500433	140/75 mm	
013500434	140/110 mm	
013500120	160/125 mm	
013500122	180/110 mm	
013500438	180/63 mm	
013500439	180/75 mm	
013500123	200/160 mm	
013500441	200/63 mm	
013500442	200/90 mm	
013500443	200/110 mm	
013500444	200/125 mm	
013500450	250/110 mm	
013500451	250/160 mm	



REDUCCION CONCENTRICA PP-H, RD 17.6



CODIGO	MEDIDA	PRECIO
014901023	63/50 mm	
014900221	75/50 mm	
014901027	75/63 mm	
014900352	90/50 mm	
014900353	90/63 mm	
014900354	90/75 mm	
014900355	110/50 mm	
014900356	110/63 mm	
014900357	110/75 mm	
014900358	110/90 mm	
014900359	125/110 mm	
014901028	125/63 mm	
014901029	125/75 mm	
014901030	125/90 mm	
014901031	140/75 mm	
014901032	140/90 mm	
014901033	140/110 mm	
014901034	140/125 mm	
014900360	160/90 mm	
014900361	160/110 mm	
014900362	160/125 mm	
014900363	160/140 mm	
014901035	180/90 mm	
014901036	180/110 mm	
014901037	180/125 mm	
014901038	180/140 mm	
014901039	180/160 mm	
014900364	200/160 mm	
014901040	200/140 mm	
014901041	200/180 mm	
014900365	225/140 mm	
014900366	225/160 mm	
014900367	225/180 mm	
014901042	225/200 mm	
014900253	250/160 mm	
014900254	250/180 mm	
014900255	250/200 mm	
014900256	250/225 mm	
014900257	280/200 mm	
014900258	280/225 mm	
014900259	280/250 mm	
014900260	315/200 mm	
014900261	315/225 mm	
014900262	315/250 mm	
014900263	315/280 mm	

REDUCCION CONCENTRICA FABRICADA PP-H, RD 17.6



CODIGO	MEDIDA	PRECIO
014900264	355/225 mm	
014900265	355/250 mm	
014900708	355/280 mm	
014900266	355/315 mm	
014900709	400/225 mm	
014900710	400/250 mm	
014900711	400/280 mm	
014900712	400/315 mm	
014900267	400/355 mm	
014900713	450/280 mm	
014900714	450/315 mm	
014900715	450/355 mm	
014900716	450/400 mm	
014900718	500/315 mm	
014900719	500/355 mm	
014900720	500/400 mm	
014900721	500/450 mm	
014900723	560/400 mm	
014900724	560/450 mm	
014900725	560/500 mm	
014900727	630/400 mm	
014900728	630/450 mm	
014900729	630/500 mm	
014900730	630/560 mm	
014900733	710/500 mm	
014900734	710/560 mm	
014900735	710/630 mm	
014900736	800/560 mm	
014900737	800/630 mm	
014900738	800/710 mm	

TAPON FABRICADO PP-H, RD 17.6

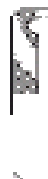

CODIGO	MEDIDA	PRECIO
013900139	250 mm	
013900141	280 mm	
013900143	315 mm	
013900145	355 mm	
013900147	400 mm	
013900149	450 mm	
013900151	500 mm	
013900153	560 mm	
013900154	630 mm	
013900155	710 mm	
013900156	800mm	

RESTRICTOR (PARA ABRAZADERA) PP-H, RD 17.6



CODIGO	MEDIDA	PRECIO
015400006	50 mm	
015400007	63 mm	
015400008	75 mm	
015400009	90 mm	
015400010	110 mm	
015400011	125 mm	
015400012	140 mm	
015400013	160 mm	
015400014	180 mm	

RESTRICTOR (PARA ABRAZADERA) PP-H, RD 17.6



CODIGO	MEDIDA	PRECIO
015400015	200 mm	
015400016	225 mm	
015400017	250 mm	
015400018	280 mm	
015400019	315 mm	
015400020	355 mm	
015400021	400 mm	
015400022	450 mm	
015400023	500 mm	

TEE FABRICADA PP-H, EXT LARGOS RD 33



CÓDIGO	MEDIDA	PRECIO
010300425	90 mm	
010300429	110 mm	
010300433	125 mm	
010300437	140 mm	
010300441	160 mm	
010300445	180 mm	
010300449	200 mm	
010300453	225 mm	
010300457	250 mm	
010300461	280 mm	
010300465	315 mm	
010300469	355 mm	
010300473	400 mm	
010300477	450 mm	
010300480	500 mm	
010300483	560mm	
010300486	630mm	
010300489	710mm	
010300492	800 mm	
010300495	900 mm	
010300497	1000 mm	

YEE 45° PP-H, EXT LARGOS RD 33



CÓDIGO	MEDIDA	PRECIO
013700662	110 mm	

CODO 90° PP-H, RD 33



CÓDIGO	MEDIDA	PRECIO
010100438	110 mm	
010100367	125 mm	
010100370	140 mm	
010100445	160 mm	
010100375	180 mm	
010100450	200 mm	
010100381	225 mm	
010100384	250 mm	
010100387	280 mm	
010100390	315 mm	
010100393	355 mm	
010100396	400 mm	

CÓDIGO
DESCUENTO

STUB END PP-H (PORTABRIDA) ISO/DIN, RD 33



CÓDIGO	MEDIDA	PRECIO
010600175	110 mm	
010600362	125 mm	
010600180	140 mm	
010600183	160 mm	
010600363	180 mm	
010600188	200 mm	
010600191	225 mm	
010600194	250 mm	
010600197	280 mm	
010600200	315 mm	
010600203	355 mm	
010600206	400 mm	
010600364	450 mm	
010600365	500 mm	
010600366	560 mm	
010600367	630 mm	

CÓDIGO
DESCUENTO

TEE PP-H, RD 33



CODIGO	MEDIDA	PRECIO
010300153	110 mm	
010300156	125 mm	
010300159	140 mm	
010300162	160 mm	
010300281	180 mm	
010300167	200 mm	
010300170	225 mm	
010300173	250 mm	
010300176	280 mm	
010300179	315 mm	
010300282	355 mm	
010300283	400 mm	

CÓDIGO
DESCUENTO

STUB END PP-H (PORTABRIDA) ISO/DIN, FABRICADA RD 33



CÓDIGO	MEDIDA	PRECIO
010600368	710 mm	
010600370	800 mm	
010600372	900 mm	
010600373	1000 mm	

CÓDIGO
DESCUENTO

ARO PARA BRIDA ACERO/PP-HG, ISO/DIN RD 11, NEGRO



CÓDIGO	MEDIDA	PRECIO
013000021	20 mm	
013000022	25 mm	
013000023	32 mm	
013000024	40 mm	
013000025	50 mm	
013000026	63 mm	
013000027	75 mm	
013000028	90 mm	
013000029	110 mm	
013000030	125 mm	
013000031	140 mm	
013000032	160 mm	
013000033	180 mm	

CÓDIGO
DESCUENTO

ARO PARA BRIDA ACERO/PP-HG, ISO/DIN RD 17, NEGRO



CÓDIGO	MEDIDA	PRECIO
013000034	200 mm	
013000035	225 mm	
013000036	250 mm	
013000037	280 mm	
013000038	315 mm	
013000039	355 mm	
013000040	400 mm	
013000041	450 mm	
013000042	500 mm	

CÓDIGO
DESCUENTO

ARO PARA BRIDA ACERO/PP-HG, ANSI 150 lbs, GRIS



CÓDIGO	MEDIDA	PRECIO
013000047	1/2" (20 mm)	
013000048	3/4" (25 mm)	
013000049	1" (32 mm)	
013000050	1 1/4" (40 mm)	
013000051	1 1/2" (50 mm)	
013000052	2" (63 mm)	
013000053	2 1/2" (75 mm)	
013000054	3" (90 mm)	
013000055	4" (110 mm)	
013000056	6" (160 mm)	
013000057	8" (200 mm)	
013000058	10" (250 mm)	
013000059	12" (315 mm)	
013000074	14" (355 mm)	
013000209	16" (400 mm)	

CÓDIGO
DESCUENTO

EMPAQUE EPDM RD 17 Y 17.6



CODIGO	MEDIDA	PRECIO
016900047	50 mm	
016900048	63 mm	
016900049	75 mm	
016900050	90 mm	
016900051	110 mm	
016900052	125 mm	
016900053	140 mm	
016900054	160 mm	
016900055	180 mm	
016900056	200 mm	
016900057	225 mm	
016900058	250 mm	
016900059	280 mm	
016900060	315 mm	
016900061	355 mm	
016900062	400 mm	
016900084	450 mm	
016900087	500 mm	
016900088	560 mm	
016900089	630 mm	
016900090	710 mm	
016900091	800 mm	
016900092	900 mm	
016900093	1000 mm	

CÓDIGO
DESCUENTO

BRIDA CIEGA ACERO/PP-HG, ISO/DIN RD 11



CODIGO	MEDIDA	PRECIO
013100003	20 mm	
013100004	25 mm	
013100005	32 mm	
013100006	40 mm	
013100007	50 mm	
013100008	63 mm	
013100009	75 mm	
013100010	90 mm	
013100011	110 mm	
013100012	125 mm	
013100013	140 mm	
013100014	160 mm	
013100015	180 mm	

CÓDIGO
DESCUENTO

EMPAQUE PERFILADO ACERO/EPDM RD 11



CODIGO	MEDIDA	PRECIO
017000004	25 mm	
017000005	32 mm	
017000006	40 mm	
017000007	50 mm	
017000008	63 mm	
017000009	75 mm	
017000010	90 mm	
017000010	110 mm	
017000011	125 mm	
017000012	140 mm	
017000013	160 mm	
017000014	180 mm	
017000014	200 mm	
017000015	225 mm	
017000003	250 mm	
017000016	280 mm	
017000017	315 mm	
017000018	355 mm	
017000019	400 mm	
017000020	450 mm	
017000021	500 mm	
017000022	560 mm	
017000053	630 mm	

CÓDIGO
DESCUENTO

BRIDA CIEGA ACERO/PP-HG, ISO/DIN RD 17



CODIGO	MEDIDA	PRECIO
013100016	200 mm	
013100017	225 mm	
013100018	250 mm	
013100019	280 mm	
013100020	315 mm	
013100021	355 mm	
013100022	400 mm	

CÓDIGO
DESCUENTO

EMPAQUE EPDM RD 11



CODIGO	MEDIDA	PRECIO
016900015	20 mm	
016900034	25 mm	
016900016	32 mm	
016900017	40 mm	
016900018	50 mm	
016900019	63 mm	
016900020	75 mm	
016900021	90 mm	
016900022	110 mm	
016900023	125 mm	
016900024	140 mm	
016900025	160 mm	
016900026	180 mm	
016900027	200 mm	
016900028	225 mm	
016900029	250 mm	
016900030	280 mm	
016900031	315 mm	
016900032	355 mm	
016900033	400 mm	
016900046	450 mm	
016900082	500 mm	
016900083	560 mm	
016900078	630 mm	

CÓDIGO
DESCUENTO

EMPAQUE PERFILADO ACERO/EPDM RD 33



CODIGO	MEDIDA	PRECIO
017000025	110 mm	
017000024	125 mm	
017000026	140 mm	
017000027	160 mm	
017000028	180 mm	
017000029	200 mm	
017000030	225 mm	
017000031	250 mm	
017000032	280 mm	
017000033	315 mm	

CÓDIGO
DESCUENTO

EMPAQUE PERFILADO FPM RD 17



CODIGO	MEDIDA	PRECIO
017000076	63 mm	
017000077	75 mm	
017000078	90 mm	
017000079	110 mm	
017000080	125 mm	
017000081	140 mm	
017000082	160 mm	
017000083	180 mm	
017000084	200 mm	
017000085	225 mm	
017000086	250 mm	
017000087	280 mm	
017000088	315 mm	
017000089	355 mm	
017000128	400 mm	

CÓDIGO
DESCUENTO

EMPAQUE PERFILADO ACERO/EPDM RD 17



CODIGO	MEDIDA	PRECIO
017000034	50 mm	
017000035	63 mm	
017000036	75 mm	
017000037	90 mm	
017000038	110 mm	
017000039	125 mm	
017000040	140 mm	
017000041	160 mm	
017000042	180 mm	
017000043	200 mm	
017000044	225 mm	
017000045	250 mm	
017000046	280 mm	
017000047	315 mm	
017000048	355 mm	
017000049	400 mm	
017000050	450 mm	
017000051	500 mm	
017000023	560 mm	
017000052	630 mm	

CÓDIGO
DESCUENTO

EMPAQUE PERFILADO FPM, SOLDADURA SOCKET



CODIGO	MEDIDA	PRECIO
017000129	16 mm	
017000109	20 mm	
017000110	25 mm	
017000111	32 mm	
017000112	40 mm	
017000113	50 mm	
017000114	63 mm	
017000115	75 mm	
017000116	90 mm	
017000117	110 mm	

CÓDIGO
DESCUENTO

EMPAQUE PERFILADO EPDM, SOLDADURA SOCKET



CODIGO	MEDIDA	PRECIO
017000118	16 mm	
017000119	20 mm	
017000120	25 mm	
017000121	32 mm	
017000122	40 mm	
017000123	50 mm	
017000124	63 mm	
017000125	75 mm	
017000126	90 mm	
017000127	110 mm	

CÓDIGO
DESCUENTO

EMPAQUE PERFILADO FPM RD 11



CODIGO	MEDIDA	PRECIO
017000091	25 mm	
017000092	32 mm	
017000093	40 mm	
017000094	50 mm	
017000095	63 mm	
017000096	75 mm	
017000097	90 mm	
017000098	110 mm	
017000099	125 mm	
017000100	140 mm	
017000101	160 mm	
017000102	180 mm	
017000103	200 mm	
017000104	225 mm	
017000105	250 mm	
017000106	280 mm	
017000107	315 mm	
017000108	355 mm	
017000090	400 mm	

ABRAZADERAS PP



CODIGO	MEDIDA	PRECIO
023800001	16 mm	
023800002	20 mm	
023800003	25 mm	
023800004	32 mm	

ABRAZADERAS PP CON OPRESOR



CODIGO	MEDIDA	PRECIO
023800005	40 mm	
023800006	50 mm	
023800007	63 mm	
023800008	75 mm	
023800009	90 mm	
023800010	110 mm	
023800011	125 mm	
023800012	140 mm	
023800013	160 mm	

ESPACIADOR PARA ABRAZADERA



CODIGO	MEDIDA	PRECIO
023800014	16 mm	
023800015	20 mm	
023800016	25 mm	
023800017	32 mm	
023800018	40 mm	
023800019	50 mm	
023800020	63 mm	
023800021	75 mm	
023800022	90 mm	
023800023	110 mm	
023800024	125 mm	
023800025	140 mm	
023800026	160 mm	

EMPAQUES PARA BRIDA (BAJO TORQUE)



EPDM CUBIERTO DE PTFE		
CÓDIGO	MEDIDA	PRECIO
3114005	1/2"	
3114007	3/4"	
3114010	1"	
3114012	1 1/4"	
3114015	1 1/2"	
3114020	2"	
3114025	2 1/2"	
3114030	3"	
3114040	4"	
3114060	6"	
3114080	8"	
3114100	10"	
3114120	12"	

EMPAQUES PARA BRIDA (BAJO TORQUE)



EPDM, ANSI B16.5		
CÓDIGO	MEDIDA	PRECIO
3113005	1/2"	
3113007	3/4"	
3113010	1"	
3113012	1 1/4"	
3113015	1 1/2"	
3113020	2"	
3113025	2 1/2"	
3113030	3"	
3113040	4"	
3113060	6"	
3113080	8"	
3113100	10"	
3113120	12"	

EMPAQUES PARA BRIDA (BAJO TORQUE)



EPDM CUBIERTO DE PVDF		
CÓDIGO	MEDIDA	PRECIO
3115005	1/2"	
3115007	3/4"	
3115010	1"	
3115015	1 1/2"	
3115020	2"	
3115030	3"	
3115040	4"	
3115060	6"	
3115080	8"	
3115100	10"	

CODO 90° PP-H, RD 11



CÓDIGO	MEDIDA	PRECIO
010200082	16 mm	
010200083	20 mm	
010200084	25 mm	
010200085	32 mm	
010200086	40 mm	
010200087	50 mm	
010200088	63 mm	
010200089	75 mm	
010200090	90 mm	
010200091	110 mm	



CODO 45° PP-H, RD 11



CÓDIGO	MEDIDA	PRECIO
010200166	16 mm	
010200092	20 mm	
010200093	25 mm	
010200094	32 mm	
010200095	40 mm	
010200096	50 mm	
010200097	63 mm	
010200098	75 mm	
010200099	90 mm	
010200100	110 mm	



TEE PP-H, RD 11



CÓDIGO	MEDIDA	PRECIO
020500014	16 mm	
020500015	20 mm	
020500016	25 mm	
020500017	32 mm	
020500018	40 mm	
020500019	50 mm	
020500020	63 mm	
020500021	75 mm	
020500022	90 mm	
020500023	110 mm	



STUB END PP-H (PORTABRIDA) ISO/DIN, RD 11



CODIGO	MEDIDA	PRECIO
015600010	16 mm	
015600043	20 mm	
015600044	25 mm	
015600024	32 mm	
015600045	40 mm	
015600046	50 mm	
015600025	63 mm	
015600017	75 mm	
015600018	90 mm	
015600019	110 mm	



STUB END PP-H (PORTABRIDA) ANSI, RD 11



CODIGO	MEDIDA	PRECIO
015600102	20 mm	
015600103	25 mm	
015600060	32 mm	
015600101	40 mm	
015600104	50 mm	
015600105	63 mm	
015600052	75 mm	
015600053	90 mm	
015600023	110 mm	



COPELE PP-H, RD 11



CODIGO	MEDIDA	PRECIO
014200018	20 mm	
014200019	25 mm	
014200020	32 mm	
014200021	40 mm	
014200022	50 mm	
014200023	63 mm	
014200024	75 mm	
014200025	90 mm	
014200026	110 mm	



REDUCCION CONCENTRICA PP-H, RD 11



CODIGO	MEDIDA	PRECIO
014900333	20/16 mm	
014900394	25/20 mm	
014900334	25/16 mm	
014900395	32/25 mm	
014900336	32/20 mm	
014900396	40/25 mm	
014900397	40/32 mm	
014900338	40/20 mm	
014900398	50/32 mm	
014900399	50/42 mm	
014900340	50/20 mm	
014900341	50/25 mm	
014900400	63/32 mm	
014900401	63/50 mm	
014900343	63/25 mm	
014900344	63/40 mm	
014900402	75/63 mm	
014900403	90/63 mm	
014900404	90/75 mm	
014900405	110/90 mm	



TAPA PP-H, RD 11



CODIGO	MEDIDA	PRECIO
020600025	16 mm	
020600006	20 mm	
020600007	25 mm	
020600008	32 mm	
020600026	40 mm	
020600009	50 mm	
020600010	63 mm	
020600027	75 mm	
020600011	90 mm	
020600012	110 mm	



TUBERIA PPs PARA VENTILACION, COLOR GRIS



CÓDIGO	MEDIDA	PRECIO
01000823	32 mm	
01000824	40 mm	
01000825	50 mm	
01000826	63 mm	
01000827	75 mm	
01000828	90 mm	
01000830	110 mm	
01000831	125 mm	
01000832	140 mm	
01000833	160 mm	
01000834	180 mm	
01000835	200 mm	
01000836	225 mm	
01000837	250 mm	
01000839	280 mm	
01000840	315 mm	
01000841	355 mm	
01000842	400 mm	
01000843	450 mm	
01000844	500 mm	
01000845	560mm	
01000846	630mm	

CÓDIGO
DESCUENTO

CODO 60° PPs

CÓDIGO	MEDIDA	PRECIO
021800114	50 mm	
021800115	63 mm	
010100760	75 mm	
010100761	90 mm	
010100762	110 mm	
010100763	125 mm	
010100764	140 mm	
010100765	160 mm	
010100766	180 mm	
010100767	200 mm	
010100768	225 mm	
010100769	250 mm	
010100770	280 mm	
010100771	315 mm	
010100772	355 mm	
010100773	400 mm	
021800116	450 mm	
021800117	500 mm	
010010221	560 mm	
010007004	630 mm	
010007005	710 mm	
010007007	800 mm	

CÓDIGO
DESCUENTO

CODO 90° PPs



CÓDIGO	MEDIDA	PRECIO
021800104	50 mm	
010100775	63 mm	
010100487	75 mm	
010100488	90 mm	
010100489	110 mm	
010100490	125 mm	
010100491	140 mm	
010100492	160 mm	
010100493	180 mm	
010100494	200 mm	
010100495	225 mm	
010100496	250 mm	
010100497	280 mm	
010100498	315 mm	
010100499	355 mm	
010100500	400 mm	
021800105	450 mm	
010100501	500 mm	
021800333	560 mm	
010100502	630 mm	
010007008	710 mm	
021800357	800 mm	

CÓDIGO
DESCUENTO

CODO 30° PPs

CÓDIGO	MEDIDA	PRECIO
021800112	50 mm	
021800113	63 mm	
010100749	75 mm	
010100750	90 mm	
010100751	110 mm	
010100752	125 mm	
010100753	140 mm	
010100465	160 mm	
010100754	180 mm	
010100466	200 mm	
010100755	225 mm	
010100467	250 mm	
010100756	280 mm	
010100468	315 mm	
010100757	355 mm	
010100758	400 mm	
021800120	450 mm	
021800121	500 mm	
010006995	560 mm	
010006997	630 mm	
010006998	710 mm	
010007000	800 mm	

CÓDIGO
DESCUENTO

CODO 45° PPs



CÓDIGO	MEDIDA	PRECIO
021800106	50 mm	
021800107	63 mm	
010100469	75 mm	
010100470	90 mm	
010100471	110 mm	
010100472	125 mm	
010100473	140 mm	
010100474	160 mm	
010100475	180 mm	
010100476	200 mm	
010100477	225 mm	
010100478	250 mm	
010100479	280 mm	
010100480	315 mm	
010100481	355 mm	
010100482	400 mm	
010100759	450 mm	
021800108	500 mm	
021800354	560 mm	
021800109	630 mm	
010007002	710 mm	
010007003	800 mm	

TEE PPs

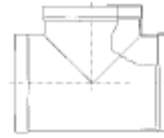

CODIGO	MEDIDA	PRECIO
022800001	50 mm	
022800002	63 mm	
010300243	75 mm	
010300244	90 mm	
010300245	110 mm	
010300246	125 mm	
010300327	140 mm	
010300247	160 mm	
010300328	180 mm	
010300248	200 mm	
010300249	225 mm	
010300250	250 mm	
010300329	280 mm	
010300251	315 mm	
010300330	355 mm	
010300331	400 mm	
022800021	450 mm	
022800022	500 mm	
022800023	560 mm	
022800024	630 mm	
010007011	710 mm	
010007012	800 mm	

COPLÉ PPs



CODIGO	MEDIDA	PRECIO
020800079	50 mm	
020800043	63 mm	
020800007	75 mm	
020800008	90 mm	
020800009	110 mm	
020800010	125 mm	
020800011	140 mm	
020800012	160 mm	
020800013	180 mm	
020800014	200 mm	
020800015	225 mm	
020800016	250 mm	
020800040	280 mm	
020800017	315 mm	
020800018	355 mm	
020800019	400 mm	
020800041	450 mm	
020800044	500 mm	
020800045	560 mm	
020800046	630 mm	
010007009	710 mm	
010007010	800 mm	

ADAPTADOR BRIDADO PPs



CODIGO	MEDIDA	PRECIO
020900047	50 mm	
020900048	63 mm	
020900013	75 mm	
020900014	90 mm	
020900001	110 mm	
020900002	125 mm	
020900009	140 mm	
020900003	160 mm	
020900010	180 mm	
020900004	200 mm	
020900005	225 mm	
020900006	250 mm	
020900011	280 mm	
020900007	315 mm	
020900012	355 mm	
020900008	400 mm	

EXTRACTOR DE AIRE PPs



CODIGO	MEDIDA	PRECIO
010007201	110 mm	
010007204	125 mm	
010007206	140 mm	
010007207	160 mm	
010007208	180 mm	
010007209	200 mm	
010007210	225 mm	
010007211	250 mm	
010007212	280 mm	
010007213	315 mm	
010007214	355 mm	
010007215	400 mm	

REDUCCION CONCENTRICA PPs



CODIGO	MEDIDA	PRECIO
022600258	75/50 mm	
014900001	90/75 mm	
014900003	110/90 mm	
014900004	125/110 mm	
014900745	140/110 mm	
014900746	140/125 mm	
014900005	160/110 mm	
014900006	160/125 mm	
014900747	160/140 mm	
014900007	180/160 mm	
022600160	200/110 mm	
014900009	200/160 mm	
014900748	200/180 mm	
014900749	225/200 mm	
014900778	225/160 mm	
014900010	250/160 mm	
014900011	250/200 mm	
014900753	250/180 mm	
014900754	250/225 mm	
022600168	280/200 mm	
014900756	280/250 mm	
014900013	315/200 mm	
014900014	315/250 mm	
014900758	315/280 mm	
014900759	355/200 mm	
014900015	355/250 mm	
014900760	355/315 mm	
022600245	400/250 mm	
014900016	400/315 mm	
014900763	400/355 mm	
022600240	450/250 mm	
022600169	450/315 mm	
022600015	450/400 mm	
022600235	500/250 mm	
022600170	500/315 mm	
022600016	500/450 mm	
022600239	560/450 mm	
010007014	630/450 mm	
022600173	710/630 mm	
022600176	800/710 mm	

JUNTA DE EXPANSION BRIDADA C/CINTA TENSORA

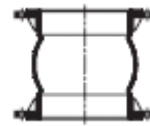

CODIGO	MEDIDA	PRECIO
010007346	50 mm	
010007347	63 mm	
010007348	75 mm	
010007349	90 mm	
010007350	110 mm	
010007352	125 mm	
010007353	140 mm	
010007354	160 mm	
010007355	200 mm	
010007356	250 mm	
010007357	315 mm	
010007358	400 mm	

JUNTA DE EXPANSION BRIDADA

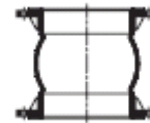

CODIGO	MEDIDA	PRECIO
010007363	50 mm	
010007364	63 mm	
010007365	75 mm	
010007366	90 mm	
010007367	110 mm	
010007368	125 mm	
010007369	140 mm	
010007370	160 mm	
010007371	200 mm	
010007372	250 mm	
010007373	315 mm	
010007374	400 mm	

TAPON PPs



CODIGO	MEDIDA	PRECIO
020100082	50 mm	
020100018	63 mm	
020100005	75 mm	
020100006	90 mm	
020100001	110 mm	
020100007	125 mm	
020100008	140 mm	
020100002	160 mm	
020100009	180 mm	
020100003	200 mm	
020100010	225 mm	
020100004	250 mm	
020100011	280 mm	
020100012	315 mm	
020100013	355 mm	
020100014	400 mm	



VÁLVULA BOLA, T-21, PP / EPDM

SOLD. CAJA DIN



CODIGO	MEDIDA	PRECIO
1638005	1/2"(20mm)	
1638007	3/4"(25mm)	
1638010	1"(32mm)	
1638012	1 1/4"(40mm)	
1638015	1 1/2"(50mm)	
1638020	2"(63mm)	
1638025	2 1/2"(75mm)	
1638030	3"(90mm)	
1638040	4"(110mm)	
1638060	6"(160mm)	



VÁLVULA BOLA, T-21, PP / EPDM

ROSCAR



CODIGO	MEDIDA	PRECIO
1619005	1/2"	
1619007	3/4"	
1619010	1"	
1619012	1 1/4"	
1619015	1 1/2"	
1619020	2"	
1619025	2 1/2"	
1619030	3"	
1619040	4"	
1619060	6"	



VÁLVULA BOLA, T-21, PP / EPDM

SOLDADURA TOPE



CODIGO	MEDIDA	PRECIO
1620005	1/2"(20mm)	
1620007	3/4"(25mm)	
1620010	1"(32mm)	
1620012	1 1/4"(40mm)	
1620015	1 1/2"(50mm)	
1620020	2"(63mm)	
1620025	2 1/2"(75mm)	
1620030	3"(90mm)	
1620040	4"(110mm)	
1620060	6"(160mm)	



VÁLVULA BOLA, T-21, PP / FKM

SOLD. CAJA DIN



CÓDIGO	MEDIDA	PRECIO
1652005	1/2"(20mm)	
1652007	3/4"(25mm)	
1652010	1"(32mm)	
1652012	1 1/4"(40mm)	
1652015	1 1/2"(50mm)	
1652020	2"(63mm)	
1652025	2 1/2"(75mm)	
1652030	3"(90mm)	
1652040	4"(110mm)	
1652060	6"(160mm)	



VÁLVULA BOLA, T-21, PP / FKM

ROSCAR



CÓDIGO	MEDIDA	PRECIO
1623005	1/2"	
1623007	3/4"	
1623010	1"	
1623012	1 1/4"	
1623015	1 1/2"	
1623020	2"	
1623025	2 1/2"	
1623030	3"	
1623040	4"	
1623060	6"	



VÁLVULA BOLA, T-21, PP / FKM

SOLDADURA TOPE

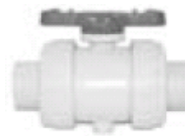

CÓDIGO	MEDIDA	PRECIO
1624005	1/2"(20mm)	
1624007	3/4"(25mm)	
1624010	1"(32mm)	
1624012	1 1/4"(40mm)	
1624015	1 1/2"(50mm)	
1624020	2"(63mm)	
1624025	2 1/2"(75mm)	
1624030	3"(90mm)	
1624040	4"(110mm)	
1624060	6"(160mm)	



VÁLVULA BOLA, T-21, PP / EPDM

BRIDADA



CODIGO	MEDIDA	PRECIO
1621005	1/2"	
1621007	3/4"	
1621010	1"	
1621012	1 1/4"	
1621015	1 1/2"	
1621020	2"	
1621025	2 1/2"	
1621030	3"	
1621040	4"	
1621060	6"	



VÁLVULA BOLA, T-21, PP / FKM

BRIDADA



CODIGO	MEDIDA	PRECIO
1625005	1/2"	
1625007	3/4"	
1625010	1"	
1625012	1 1/4"	
1625015	1 1/2"	
1625020	2"	
1625025	2 1/2"	
1625030	3"	
1625040	4"	
1625060	6"	





VÁLVULA BOLA TRES VIAS, T-23, PP/FKM

SOLD. CAJA DIN



CODIGO	MEDIDA	PRECIO
2527005	1/2"(20mm)	
2527007	3/4"(25mm)	
2527010	1"(32mm)	
2527012	1 1/4"(40mm)	
2527015	1 1/2"(50mm)	
2527020	2"(63mm)	
2527030	3"(90mm)	
2527040	4"(110mm)	

CÓDIGO
DESCUENTO

VÁLVULA DE TRES VIAS, TRIPLE UNION, T-23, PP/FKM

ROSCAR



CODIGO	MEDIDA	PRECIO
2529005	1/2"	
2529007	3/4"	
2529010	1"	
2529012	1 1/4"	
2529015	1 1/2"	
2529020	2"	
2529030	3"	
2529040	4"	

CÓDIGO
DESCUENTO

VÁLVULA DE TRES VIAS, TRIPLE UNION, T-23, PP/FKM

SOLDADURA TOPE



CODIGO	MEDIDA	PRECIO
2530005	1/2"(20mm)	
2530007	3/4"(25mm)	
2530010	1"(32mm)	
2530012	1 1/4"(40mm)	
2530015	1 1/2"(50mm)	
2530020	2"(63mm)	
2530030	3"(90mm)	
2530040	4"(110mm)	

CÓDIGO
DESCUENTO

VÁLVULA DE TRES VIAS, T-23, PP / FKM

BRIDADA



CODIGO	MEDIDA	PRECIO
2531005	1/2"	
2531007	3/4"	
2531010	1"	
2531012	1 1/4"	
2531015	1 1/2"	
2531020	2"	
2531040	4"	
2531060	6"	

CÓDIGO
DESCUENTO

ESFERA PUERTO-T

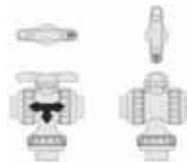

CODIGO	MEDIDA	PRECIO
3033005	1/2"	
3033007	3/4"	
3033010	1"	
3033015	1 1/4" - 1 1/2"	
3033020	2"	
3033030	3"	
3033040	4" - 6"	

CÓDIGO
DESCUENTO

ESFERA PUERTO TRIPLE L



CODIGO	MEDIDA	PRECIO
3081005	1/2"	
3081007	3/4"	
3081010	1"	
3081015	1 1/4" - 1 1/2"	
3081020	2"	
3081030	3"	
3081040	4" - 6"	

CÓDIGO
DESCUENTO

ESFERA PUERTO-CRUZ



CODIGO	MEDIDA	PRECIO
3029005	1/2"	
3029007	3/4"	
3029010	1"	
3029012	1 1/4"	
3029015	1 1/2"	
3029020	2"	

CÓDIGO
DESCUENTO

ESFERA PUERTO DOBLE L



CODIGO	MEDIDA	PRECIO
3037005	1/2"	
3037007	3/4"	
3037010	1"	
3037015	1 1/4" - 1 1/2"	
3037020	2"	
3037030	3"	
3037040	4" - 6"	

CÓDIGO
DESCUENTO

VÁLVULA MARIPOSA T-57, PP / PP / EPDM

OPERADOR PALANCA



CODIGO	MEDIDA	PRECIO
3752015	1 1/2"	
3752020	2"	
3752025	2 1/2"	
3752030	3"	
3752040	4"	
3752050	5"	
3752060	6"	
3752080	8"	

CÓDIGO
DESCUENTO

VÁLVULA MARIPOSA T-57, PP / PP / FKM

OPERADOR PALANCA



CODIGO	MEDIDA	PRECIO
3753015	1 1/2"	
3753020	2"	
3753025	2 1/2"	
3753030	3"	
3753040	4"	
3753050	5"	
3753060	6"	
3753080	8"	

CÓDIGO
DESCUENTO



VÁLVULA MARIPOSA T-57, PP / PVDF / EPDM
OPERADOR PALANCA



CODIGO	MEDIDA	PRECIO
3740015	1½"	
3740020	2"	
3740025	2½"	
3740030	3"	
3740040	4"	
3740050	5"	
3740060	6"	
3740080	8"	

VÁLVULA MARIPOSA T-57, PP / PVDF / FKM
OPERADOR PALANCA



CODIGO	MEDIDA	PRECIO
3741015	1½"	
3741020	2"	
3741025	2½"	
3741030	3"	
3741040	4"	
3741050	5"	
3741060	6"	
3741080	8"	

VÁLVULA MARIPOSA T-57, PP / PP / EPDM

OPERADOR PLASGEAR



CODIGO	MEDIDA	PRECIO
3726015	1½"	
3726020	2"	
3726025	2½"	
3726030	3"	
3726040	4"	
3726050	5"	
3726060	6"	
3726080	8"	
3726100	10"	
3726120	12"	
3726140	14"	
3726160	16"	

VÁLVULA MARIPOSA T-57, PP / PP / FKM

OPERADOR PLASGEAR



CODIGO	MEDIDA	PRECIO
3727015	1½"	
3727020	2"	
3727025	2½"	
3727030	3"	
3727040	4"	
3727050	5"	
3727060	6"	
3727080	8"	
3727100	10"	
3727120	12"	
3727140	14"	
3727160	16"	

VÁLVULA MARIPOSA T-57, PP / PVDF / EPDM

OPERADOR PLASGEAR



CODIGO	MEDIDA	PRECIO
3736015	1½"	
3736020	2"	
3736025	2½"	
3736030	3"	
3736040	4"	
3736050	5"	
3736060	6"	
3736080	8"	
3736100	10"	
3736120	12"	
3736140	14"	
3736160	16"	

VÁLVULA MARIPOSA T-57, PP / PVDF / FKM

OPERADOR PLASGEAR



CODIGO	MEDIDA	PRECIO
3737015	1½"	
3737020	2"	
3737025	2½"	
3737030	3"	
3737040	4"	
3737050	5"	
3737060	6"	
3737080	8"	
3737100	10"	
3737120	12"	
3737140	14"	
3737160	16"	

VÁLVULA MARIPOSA T-75, PP / PVDF / EPDM

OPERADOR METAL GEAR



CODIGO	MEDIDA	PRECIO
3804180	18"	
3804200	20"	
3804240	24"	

VÁLVULA MARIPOSA T-75, PP / PVDF / FKM

OPERADOR METAL GEAR



CODIGO	MEDIDA	PRECIO
3805180	18"	
3805200	20"	
3805240	24"	



VÁLVULA MARIPOSA T-57, PP / PP / EPDM
OPERADOR PALANCA



VASTAGO SS 304

CODIGO	MEDIDA	PRECIO
3860015	1½"	
3860020	2"	
3860025	2½"	
3860030	3"	
3860040	4"	
3860060	6"	
3860080	8"	

VASTAGO SS 316

CODIGO	MEDIDA	PRECIO
3861015	1½"	
3861020	2"	
3861025	2½"	
3861030	3"	
3861040	4"	
3861060	6"	
3861080	8"	

VÁLVULA MARIPOSA T-57, PP / PP / FKM
OPERADOR PALANCA



VASTAGO SS 304

CODIGO	MEDIDA	PRECIO
3862015	1½"	
3862020	2"	
3862025	2½"	
3862030	3"	
3862040	4"	
3862060	6"	
3862080	8"	

VASTAGO SS 316

CODIGO	MEDIDA	PRECIO
3863015	1½"	
3863020	2"	
3863025	2½"	
3863030	3"	
3863040	4"	
3863060	6"	
3863080	8"	

VÁLVULA MARIPOSA T-57 PP / PVDF / EPDM
OPERADOR PALANCA



VASTAGO SS 304

CODIGO	MEDIDA	PRECIO
3864015	1½"	
3864020	2"	
3864025	2½"	
3864030	3"	
3864040	4"	
3864060	6"	
3864080	8"	

VASTAGO SS 316

CODIGO	MEDIDA	PRECIO
3865015	1½"	
3865020	2"	
3865025	2½"	
3865030	3"	
3865040	4"	
3865060	6"	
3865080	8"	

VÁLVULA MARIPOSA T-57, PP / PVDF / FKM
OPERADOR PALANCA



VASTAGO SS 304

CODIGO	MEDIDA	PRECIO
3866015	1½"	
3866020	2"	
3866025	2½"	
3866030	3"	
3866040	4"	
3866060	6"	
3866080	8"	

VASTAGO SS 316

CODIGO	MEDIDA	PRECIO
3867015	1½"	
3867020	2"	
3867025	2½"	
3867030	3"	
3867040	4"	
3867060	6"	
3867080	8"	



VÁLVULA MARIPOSA T-57, PP / PP / EPDM
OPERADOR PLASGEAR

CÓDIGO
DESCUENTO



VASTAGO SS 304

CODIGO	MEDIDA	PRECIO
3832015	1½"	
3832020	2"	
3832025	2½"	
3832030	3"	
3832040	4"	
3832060	6"	
3832080	8"	
3832100	10"	
3832120	12"	
3832140	14"	
3832160	16"	

VASTAGO SS 316

CODIGO	MEDIDA	PRECIO
3833015	1½"	
3833020	2"	
3833025	2½"	
3833030	3"	
3833040	4"	
3833060	6"	
3833080	8"	
3833100	10"	
3833120	12"	
3833140	14"	
3833160	16"	

VÁLVULA MARIPOSA T-57, PP / PP / FKM
OPERADOR PLASGEAR

CÓDIGO
DESCUENTO



VASTAGO SS 304

CODIGO	MEDIDA	PRECIO
3834015	1½"	
3834020	2"	
3834025	2½"	
3834030	3"	
3834040	4"	
3834060	6"	
3834080	8"	
3834100	10"	
3834120	12"	
3834140	14"	
3834160	16"	

VASTAGO SS 316

CODIGO	MEDIDA	PRECIO
3835015	1½"	
3835020	2"	
3835025	2½"	
3835030	3"	
3835040	4"	
3835060	6"	
3835080	8"	
3835100	10"	
3835120	12"	
3835140	14"	
3835160	16"	

VÁLVULA MARIPOSA T-75, PP / PP / EPDM
OPERADOR METAL GEAR

CÓDIGO
DESCUENTO



VASTAGO SS 304

CODIGO	MEDIDA	PRECIO
3840180	18"	
3840200	20"	
3840240	24"	

VASTAGO SS 316

CODIGO	MEDIDA	PRECIO
3841180	18"	
3841200	20"	
3841240	24"	

VÁLVULA MARIPOSA T-75, PP / PP / FKM
OPERADOR METAL GEAR

CÓDIGO
DESCUENTO



VASTAGO SS 304

CODIGO	MEDIDA	PRECIO
3842180	18"	
3842200	20"	
3842240	24"	

VASTAGO SS 316

CODIGO	MEDIDA	PRECIO
3843180	18"	
3843200	20"	
3843240	24"	



VÁLVULA MARIPOSA T-57, PP / PVDF / EPDM
OPERADOR PLASGEAR

CÓDIGO
DESCUENTO



VASTAGO SS 304

CODIGO	MEDIDA	PRECIO
3836015	1½"	
3836020	2"	
3836025	2½"	
3836030	3"	
3836040	4"	
3836060	6"	
3836080	8"	
3836100	10"	
3836120	12"	
3836140	14"	
3836160	16"	

VASTAGO SS 316

CODIGO	MEDIDA	PRECIO
3837015	1½"	
3837020	2"	
3837025	2½"	
3837030	3"	
3837040	4"	
3837060	6"	
3837080	8"	
3837100	10"	
3837120	12"	
3837140	14"	
3837160	16"	

VÁLVULA MARIPOSA T-57, PP / PVDF / FKM
OPERADOR PLASGEAR

CÓDIGO
DESCUENTO



VASTAGO SS 304

CODIGO	MEDIDA	PRECIO
3838015	1½"	
3838020	2"	
3838025	2½"	
3838030	3"	
3838040	4"	
3838060	6"	
3838080	8"	
3838100	10"	
3838120	12"	
3838140	14"	
3838160	16"	

VASTAGO SS 316

CODIGO	MEDIDA	PRECIO
3839015	1½"	
3839020	2"	
3839025	2½"	
3839030	3"	
3839040	4"	
3839060	6"	
3839080	8"	
3839100	10"	
3839120	12"	
3839140	14"	
3839160	16"	

VÁLVULA MARIPOSA T-75, PP / PVDF / EPDM
OPERADOR METAL GEAR

CÓDIGO
DESCUENTO



VASTAGO SS 304

CODIGO	MEDIDA	PRECIO
3844180	18"	
3844200	20"	
3844240	24"	

VASTAGO SS 316

CODIGO	MEDIDA	PRECIO
3845180	18"	
3845200	20"	
3845240	24"	

VÁLVULA MARIPOSA T-75, PP / PVDF / FKM
OPERADOR METAL GEAR

CÓDIGO
DESCUENTO



VASTAGO SS 304

CODIGO	MEDIDA	PRECIO
3846180	18"	
3846200	20"	
3846240	24"	

VASTAGO SS 316

CODIGO	MEDIDA	PRECIO
3847180	18"	
3847200	20"	
3847240	24"	



VÁLVULA DIAFRAGMA, T-14, PP / PP / EPDM

CÓDIGO
DESCUENTO

SOLD. CAJA DIN



CODIGO	MEDIDA	PRECIO
1535005	½"(20mm)	
1535007	¾"(25mm)	
1535010	1"(32mm)	
1535012	1¼"(40mm)	
1535015	1½"(50mm)	
1535020	2"(63mm)	

ROSCAR



CODIGO	MEDIDA	PRECIO
1537005	½"	
1537007	¾"	
1537010	1"	
1537012	1¼"	
1537015	1½"	
1537020	2"	

SOLDADURA TOPE



CODIGO	MEDIDA	PRECIO
1536005	½"(20mm)	
1536007	¾"(25mm)	
1536010	1"(32mm)	
1536012	1¼"(40mm)	
1536015	1½"(50mm)	
1536020	2"(63mm)	

DISPONIBLES CON TORNILLOS DE TITANIO, COTIZAR

VÁLVULA DIAFRAGMA, T-14, PP / PP / TEFLON

CÓDIGO
DESCUENTO

SOLD. CAJA DIN



CODIGO	MEDIDA	PRECIO
1539005	½"(20mm)	
1539007	¾"(25mm)	
1539010	1"(32mm)	
1539012	1¼"(40mm)	
1539015	1½"(50mm)	
1539020	2"(63mm)	

ROSCAR



CODIGO	MEDIDA	PRECIO
1541005	½"	
1541007	¾"	
1541010	1"	
1541012	1¼"	
1541015	1½"	
1541020	2"	

SOLDADURA TOPE



CODIGO	MEDIDA	PRECIO
1540005	½"(20mm)	
1540007	¾"(25mm)	
1540010	1"(32mm)	
1540012	1¼"(40mm)	
1540015	1½"(50mm)	
1540020	2"(63mm)	

EL DIAFRAGMA DE TEFLON INCLUYE BARRERA DE GAS EN PVDF
DISPONIBLES CON TORNILLOS DE TITANIO, COTIZAR

VÁLVULA DIAFRAGMA, PP / PP / EPDM - BRIDADA

CÓDIGO
DESCUENTO

T-14



CODIGO	MEDIDA	PRECIO
1465005	½"	
1465007	¾"	
1465010	1"	
1465012	1¼"	
1465015	1½"	
1465020	2"	
1465025	2½"	
1465030	3"	
1465040	4"	

T-15



CODIGO	MEDIDA	PRECIO
1465060	6"	

T-G



CODIGO	MEDIDA	PRECIO
1132080	8"	
1132100	10"	

DISPONIBLES CON TORNILLOS DE TITANIO, COTIZAR

VÁLVULA DIAFRAGMA, PP / PP / TEFLON - BRIDADA

CÓDIGO
DESCUENTO

T-14



CODIGO	MEDIDA	PRECIO
1466005	½"	
1466007	¾"	
1466010	1"	
1466012	1¼"	
1466015	1½"	
1466020	2"	
1466025	2½"	
1466030	3"	
1466040	4"	

T-15



CODIGO	MEDIDA	PRECIO
1466060	6"	

T-G



CODIGO	MEDIDA	PRECIO
1133080	8"	
1133100	10"	

EL DIAFRAGMA DE TEFLON INCLUYE BARRERA DE GAS EN PVDF
DISPONIBLES CON TORNILLOS DE TITANIO, COTIZAR



VÁLV. DIAFRAGMA C/ACTUADOR NEUMATICO AIRE/AIRE

T-14, PP / PPG / EPDM

**CÓDIGO
DESCUENTO**

SOLD. CAJA DIN



CODIGO	MEDIDA	PRECIO
1847005	½"(20mm)	
1847007	¾"(25mm)	
1847010	1"(32mm)	
1847012	1¼"(40mm)	
1847015	1½"(50mm)	
1847020	2"(63mm)	

ROSCAR



CODIGO	MEDIDA	PRECIO
1848005	½"	
1848007	¾"	
1848010	1"	
1848012	1¼"	
1848015	1½"	
1848020	2"	

SOLDADURA TOPE



CODIGO	MEDIDA	PRECIO
1861005	½"(20mm)	
1861007	¾"(25mm)	
1861010	1"(32mm)	
1861012	1¼"(40mm)	
1861015	1½"(50mm)	
1861020	2"(63mm)	

VÁLV. DIAFRAGMA C/ACTUADOR NEUMATICO AIRE/AIRE

T-14, PP / PPG / TEFLON

**CÓDIGO
DESCUENTO**

SOLD. CAJA DIN



CODIGO	MEDIDA	PRECIO
1849005	½"(20mm)	
1849007	¾"(25mm)	
1849010	1"(32mm)	
1849012	1¼"(40mm)	
1849015	1½"(50mm)	
1849020	2"(63mm)	

ROSCAR



CODIGO	MEDIDA	PRECIO
1850005	½"	
1850007	¾"	
1850010	1"	
1850012	1¼"	
1850015	1½"	
1850020	2"	

SOLDADURA TOPE



CODIGO	MEDIDA	PRECIO
1862005	½"(20mm)	
1862007	¾"(25mm)	
1862010	1"(32mm)	
1862012	1¼"(40mm)	
1862015	1½"(50mm)	
1862020	2"(63mm)	

VÁLV. DIAFRAGMA C/ACTUADOR NEUMATICO AIRE/RESORTE

T-14, PP / PPG / EPDM

**CÓDIGO
DESCUENTO**

SOLD. CAJA DIN



CODIGO	MEDIDA	PRECIO
1844005	½"(20mm)	
1844007	¾"(25mm)	
1844010	1"(32mm)	
1844012	1¼"(40mm)	
1844015	1½"(50mm)	
1844020	2"(63mm)	

ROSCAR



CODIGO	MEDIDA	PRECIO
1842005	½"	
1842007	¾"	
1842010	1"	
1842012	1¼"	
1842015	1½"	
1842020	2"	

SOLDADURA TOPE

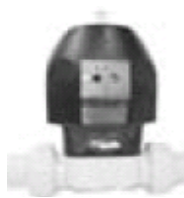

CODIGO	MEDIDA	PRECIO
1867005	½"(20mm)	
1867007	¾"(25mm)	
1867010	1"(32mm)	
1867012	1¼"(40mm)	
1867015	1½"(50mm)	
1867020	2"(63mm)	

VÁLV. DIAFRAGMA C/ACTUADOR NEUMATICO AIRE/RESORTE

T-14, PP / PPG / TEFLON

**CÓDIGO
DESCUENTO**

SOLD. CAJA DIN

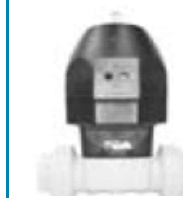

CODIGO	MEDIDA	PRECIO
1843005	½"(20mm)	
1843007	¾"(25mm)	
1843010	1"(32mm)	
1843012	1¼"(40mm)	
1843015	1½"(50mm)	
1843020	2"(63mm)	

ROSCAR



CODIGO	MEDIDA	PRECIO
1841005	½"	
1841007	¾"	
1841010	1"	
1841012	1¼"	
1841015	1½"	
1841020	2"	

SOLDADURA TOPE

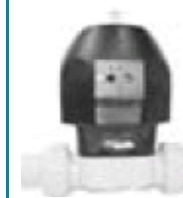

CODIGO	MEDIDA	PRECIO
1868005	½"(20mm)	
1868007	¾"(25mm)	
1868010	1"(32mm)	
1868012	1¼"(40mm)	
1868015	1½"(50mm)	
1868020	2"(63mm)	



VÁLV. DIAFRAGMA C/ACTUADOR NEUMATICO AIRE/AIRE
T-14, BRIDADA

CÓDIGO
DESCUENTO

PP / PPG / EPDM		
CODIGO	MEDIDA	PRECIO
1417005	1/2"	
1417007	3/4"	
1417010	1"	
1417012	1 1/4"	
1417015	1 1/2"	
1417020	2"	
PP / PPG / TEFLON		
CODIGO	MEDIDA	PRECIO
1418005	1/2"	
1418007	3/4"	
1418010	1"	
1418012	1 1/4"	
1418015	1 1/2"	
1418020	2"	

VÁLV. DIAFRAGMA C/ACTUADOR NEUMATICO AIRE/RESORTE
T-14, BRIDADA

CÓDIGO
DESCUENTO

PP / PPG / EPDM		
CODIGO	MEDIDA	PRECIO
1427005	1/2"	
1427007	3/4"	
1427010	1"	
1427012	1 1/4"	
1427015	1 1/2"	
1427020	2"	
PP / PPG / TEFLON		
CODIGO	MEDIDA	PRECIO
1428005	1/2"	
1428007	3/4"	
1428010	1"	
1428012	1 1/4"	
1428015	1 1/2"	
1428020	2"	

OPCIONES DE ACTUADOR NEUMATICO

CÓDIGO
DESCUENTO

LIMIT SWITCH		
CODIGO	MEDIDA	PRECIO
2460779		
SOLENOIDE NEMA 4X PLASTICO 120V		
2401779		
SOLENOIDE NEMA 7 PLASTICO 120V		
2401780		
POSICIONADOR 4-20 MA PARA A-A		
2455000		
POSICIONADOR 4-20 MA PARA A-R		
2452000		

VÁLVULA CHECK DE BOLA, PP / EPDM

CÓDIGO
DESCUENTO

SOLD. CAJA DIN		
CODIGO	MEDIDA	PRECIO
1272005	1/2"(20mm)	
1272007	3/4"(25mm)	
1272010	1"(32mm)	
1272012	1 1/4"(40mm)	
1272015	1 1/2"(50mm)	
1272020	2"(63mm)	
1272030	3"(90mm)	
1272040	4"(110mm)	

VÁLVULA CHECK DE BOLA, PP / FKM

CÓDIGO
DESCUENTO

SOLD. CAJA DIN		
CODIGO	MEDIDA	PRECIO
1276005	1/2"(20mm)	
1276007	3/4"(25mm)	
1276010	1"(32mm)	
1276012	1 1/4"(40mm)	
1276015	1 1/2"(50mm)	
1276020	2"(63mm)	
1276030	3"(90mm)	
1276040	4"(110mm)	
ROSCAR		
CODIGO	MEDIDA	PRECIO
1227005	1/2"	
1227007	3/4"	
1227010	1"	
1227012	1 1/4"	
1227015	1 1/2"	
1227020	2"	
1227030	3"	
1227040	4"	
SOLDADURA TOPE		
CODIGO	MEDIDA	PRECIO
1228005	1/2"(20mm)	
1228007	3/4"(25mm)	
1228010	1"(32mm)	
1228012	1 1/4"(40mm)	
1228015	1 1/2"(50mm)	
1228020	2"(63mm)	
1228030	3"(90mm)	
1228040	4"(110mm)	

ROSCAR		
CODIGO	MEDIDA	PRECIO
1223005	1/2"	
1223007	3/4"	
1223010	1"	
1223012	1 1/4"	
1223015	1 1/2"	
1223020	2"	
1223030	3"	
1223040	4"	

SOLDADURA TOPE		
CODIGO	MEDIDA	PRECIO
1224005	1/2"(20mm)	
1224007	3/4"(25mm)	
1224010	1"(32mm)	
1224012	1 1/4"(40mm)	
1224015	1 1/2"(50mm)	
1224020	2"(63mm)	
1224030	3"(90mm)	
1224040	4"(110mm)	



VÁLVULA CHECK COLUMPIO, PP / EPDM

BRIDADA	CÓDIGO		PRECIO
	CÓDIGO	MEDIDA	
	1202007	¾"	
	1202010	1"	
	1202015	1½"	
	1202020	2"	
	1202025	2½"	
	1202030	3"	
	1202040	4"	
	1202060	6"	
	1202080	8"	

VÁLVULAS CHECK TIPO WAFER CON RESORTE

PP / EPDM, RESORTE SS	CÓDIGO		PRECIO
	CÓDIGO	MEDIDA	
	WC4200ES	2"	
	WC4250ES	2½"	
	WC4300ES	3"	
	WC4400ES	4"	
	WC4600ES	6"	
	WC4800ES	8"	
	WC41000ES	10"	
	WC41200ES	12"	
	WC41400ES	14"	
	WC41600ES	16"	
	WC42000ES	20"	

PP / FPM, RESORTE SS	CÓDIGO		PRECIO
	CÓDIGO	MEDIDA	
	WC4200VS	2"	
	WC4250VS	2½"	
	WC4300VS	3"	
	WC4400VS	4"	
	WC4600VS	6"	
	WC4800VS	8"	
	WC41000VS	10"	
	WC41200VS	12"	
	WC41400VS	14"	
	WC41600VS	16"	
	WC42000VS	20"	

PP / TEFLON, RESORTE HASTELLOY	CÓDIGO		PRECIO
	CÓDIGO	MEDIDA	
	WC4200PH	2"	
	WC4250PH	2½"	
	WC4300PH	3"	
	WC4400PH	4"	
	WC4600PH	6"	
	WC4800PH	8"	
	WC41000PH	10"	
	WC41200PH	12"	
	WC41400PH	14"	
	WC41600PH	16"	
	WC42000PH	20"	

VÁLVULA CHECK DE BOLA BRIDADA

PP / EPDM	CÓDIGO		PRECIO
	CÓDIGO	MEDIDA	
	1225005	½"	
	1225007	¾"	
	1225010	1"	
	1225012	1¼"	
	1225015	1½"	
	1225020	2"	
	1225030	3"	
	1225040	4"	

PP / FKM	CÓDIGO		PRECIO
	CÓDIGO	MEDIDA	
	1229005	½"	
	1229007	¾"	
	1229010	1"	
	1229012	1¼"	
	1229015	1½"	
	1229020	2"	
	1229030	3"	
	1229040	4"	

VÁLVULAS CHECK TIPO WAFER SIN RESORTE

PP / EPDM	CÓDIGO		PRECIO
	CÓDIGO	MEDIDA	
	WC4200E	2"	
	WC4250E	2½"	
	WC4300E	3"	
	WC4400E	4"	
	WC4600E	6"	
	WC4800E	8"	
	WC41000E	10"	
	WC41200E	12"	
	WC41400E	14"	
	WC41600E	16"	
	WC42000E	20"	

PP / FPM	CÓDIGO		PRECIO
	CÓDIGO	MEDIDA	
	WC4200V	2"	
	WC4250V	2½"	
	WC4300V	3"	
	WC4400V	4"	
	WC4600V	6"	
	WC4800V	8"	
	WC41000V	10"	
	WC41200V	12"	
	WC41400V	14"	
	WC41600V	16"	
	WC42000V	20"	

PP / TEFLON	CÓDIGO		PRECIO
	CÓDIGO	MEDIDA	
	WC4200P	2"	
	WC4250P	2½"	
	WC4300P	3"	
	WC4400P	4"	
	WC4600P	6"	
	WC4800P	8"	
	WC41000P	10"	
	WC41200P	12"	
	WC41400P	14"	
	WC41600P	16"	
	WC42000P	20"	



VÁLVULA GLOBO, PP / EPDM



SOLD. CAJA DIN

CODIGO	MEDIDA	PRECIO
1264005	1/2"(20mm)	
1264007	3/4"(25mm)	
1264010	1"(32mm)	

ROSCAR

CODIGO	MEDIDA	PRECIO
1265005	1/2"	
1265007	3/4"	
1265010	1"	

CÓDIGO
DESCUENTO

ESPACIADOR PARA WAFER CHEK



ESPACIADOR PP

CÓDIGO	MEDIDA	PRECIO
WCX402SP	2"	
WCX425SP	2 1/2"	
WCX403SP	3"	
WCX404SP	4"	
WCX406SP	6"	
WCX408SP	8"	
WCX410SP	10"	
WCX412SP	12"	

CÓDIGO
DESCUENTO

VÁLVULA GLOBO, PP / EPDM



BRIDADA

CODIGO	MEDIDA	PRECIO
1266005	1/2"	
1266007	3/4"	
1266010	1"	
1266015	1 1/2"	
1266020	2"	
1266025	2 1/2"	
1266030	3"	
1266040	4"	

CÓDIGO
DESCUENTO

VÁLVULA GLOBO, PP / FKM



SOLD. CAJA DIN

CODIGO	MEDIDA	PRECIO
1287005	1/2"(20mm)	
1287007	3/4"(25mm)	
1287010	1"(32mm)	

ROSCAR

CODIGO	MEDIDA	PRECIO
1288005	1/2"	
1288007	3/4"	
1288010	1"	

CÓDIGO
DESCUENTO

VÁLVULA GLOBO DE CONTROL, ELECTRICA



PP / BRIDADA, C/POSICIONADOR 4-20 mA

CODIGO	MEDIDA	PRECIO
2202005	1/2"	
2202007	3/4"	
2202010	1"	
2202015	1 1/2"	
2202020	2"	
2202025	2 1/2"	
2202030	3"	
2202040	4"	

SE REQUIERE LLENAR FORMATO DE ESPECIFICACION

CÓDIGO
DESCUENTO

VÁLVULA GLOBO, PP / FKM



BRIDADA

CODIGO	MEDIDA	PRECIO
1289005	1/2"	
1289007	3/4"	
1289010	1"	
1289015	1 1/2"	
1289020	2"	
1289025	2 1/2"	
1289030	3"	
1289040	4"	

CÓDIGO
DESCUENTO

POSICIONADOR P/VÁLV. GLOBO CONTROL NEUMATICA



3-15 PSI PARA A-R

CODIGO	MEDIDA	PRECIO
2455762		

4-20 MA PARA A-R

CODIGO	MEDIDA	PRECIO
2456762		

CÓDIGO
DESCUENTO

VÁLVULA GLOBO DE CONTROL, NEUMATICA (A-S)



PP / BRIDADA

CODIGO	MEDIDA	PRECIO
2502005	1/2"	
2502007	3/4"	
2502010	1"	
2502012	1 1/4"	
2502015	1 1/2"	
2502020	2"	
2502025	2 1/2"	
2502030	3"	
2502040	4"	

SE REQUIERE LLENAR FORMATO DE ESPECIFICACION

CÓDIGO
DESCUENTO

VÁLVULA DE AGUJA



PP / FKM - ROSCAR

CÓDIGO	MEDIDA	PRECIO
NV40025T	1/4"	
NV40037T	3/8"	
NV40050T	1/2"	

CÓDIGO
DESCUENTO

VÁLV. DE INDICADOR NIVEL, PP/FKM



ANSI X SOLD. CAJA DIN

CODIGO	MEDIDA	PRECIO
1337007	3/4" x 20 mm	
1337010	1" x 25 mm	

CÓDIGO
DESCUENTO

VÁLV. DE INDICADOR NIVEL, PP/EPDM



ANSI X SOLD. CAJA DIN

CODIGO	MEDIDA	PRECIO
1336007	3/4" x 20 mm	
1337010	1" x 25 mm	

CÓDIGO
DESCUENTO



ADAPTADOR PARA TANQUE



PP / FPM - ROSC x ROSC

CÓDIGO	MEDIDA	PRECIO
BFA3005TFS	1/2"	
BFA3007TFS	3/4"	
BFA3010TFS	1"	
BFA3012TFS	1 1/4"	
BFA3015TFS	1 1/2"	
BFA3020TFS	2"	
BFA3030TFS	3"	
BFA3040TFS	4"	
BFA3060TFS	6"	

PP / EPDM - ROSC x ROSC

CÓDIGO	MEDIDA	PRECIO
BFA3005TES	1/2"	
BFA3007TES	3/4"	
BFA3010TES	1"	
BFA3012TES	1 1/4"	
BFA3015TES	1 1/2"	
BFA3020TES	2"	
BFA3030TES	3"	
BFA3040TES	4"	
BFA3060TES	6"	



SELLO QUÍMICO PP/PTEF, C/ MANOMETRO



0-0.6 Bar

CÓDIGO	MEDIDA	PRECIO
17000335A	1/4"x25mm	
17000346A	1/2" x32mm	

0-1.0 Bar

CÓDIGO	MEDIDA	PRECIO
17000335B	1/4"x25mm	
17000346B	1/2" x32mm	

0-1.6 Bar

CÓDIGO	MEDIDA	PRECIO
17000335C	1/4"x25mm	
17000346C	1/2" x32mm	

0-2.5 BAR

CÓDIGO	MEDIDA	PRECIO
17000335D	1/4"x25mm	
17000346D	1/2" x32mm	

0-4 BAR

CÓDIGO	MEDIDA	PRECIO
17000335E	1/4"x25mm	
17000346E	1/2" x32mm	

0-6 BAR

CÓDIGO	MEDIDA	PRECIO
17000335F	1/4"x25mm	
17000346F	1/2" x32mm	

0-10 BAR

CÓDIGO	MEDIDA	PRECIO
17000335G	1/4"x25mm	
17000346G	1/2" x32mm	



ADAPTADOR PARA TANQUE, EXTREMO LARGO



PP / FPM - ROSC x ROSC

CÓDIGO	MEDIDA	PRECIO
BFA3005TFL	1/2"	
BFA3007TFL	3/4"	
BFA3010TFL	1"	

PP / EPDM - ROSC x ROSC

CÓDIGO	MEDIDA	PRECIO
BFA3005TEL	1/2"	
BFA3007TEL	3/4"	
BFA3010TEL	1"	



SELLO QUÍMICO PP/PTEF



CÓDIGO	MEDIDA	PRECIO
17000333	1/4"x25mm	
17000334	1/2" x32mm	



SELLO QUÍMICO



PP / FPM

CÓDIGO	MEDIDA	PRECIO
GG3025X25	1/4" x 1/4"	



MANOMETRO SS (RELLENO DE GLICERINA)



(0-160 PSI)

CÓDIGO	MEDIDA	PRECIO
GG160DUALF	2"-1/2"	



MANOMETRO ESTANDAR



(0-30 PSI)

CÓDIGO	MEDIDA	PRECIO
GG030DUAL	2"	

(0-60 PSI)

CÓDIGO	MEDIDA	PRECIO
GG060DUAL	2"	

(0-160 PSI)

CÓDIGO	MEDIDA	PRECIO
GG160DUAL	2"	



SELLO QUÍMICO PP/FPM, C/ MANOMETRO SS (RELLENO DE GLICERINA)



(0-160 PSI)

CÓDIGO	MEDIDA	PRECIO
GG316025SL	1/4" x 1/4"	



SELLO QUÍMICO C/ MANOMETRO



PP/FPM (0-30 PSI)

CÓDIGO	MEDIDA	PRECIO
GG303025	1/4" x 1/4"	

PP/FPM (0-60 PSI)

CÓDIGO	MEDIDA	PRECIO
GG306025	1/4" x 1/4"	

PP/FPM (0-160 PSI)

CÓDIGO	MEDIDA	PRECIO
GG316025	1/4" x 1/4"	





REGULADOR DE PRESION C/MANOMETRO

MOD. V182/82, PP / PTFE

	SOLD. TOPE		
	CODIGO	MEDIDA	PRECIO
500241105	½" (20 mm)		
500241107	¾"(25mm)		
500241110	1"(32mm)		
500241112	1¼"(40mm)		
500241115	1½"(50mm)		
500241120	2"(63mm)		
500241125	2½" (75 mm)		
500241130	3"(90mm)		
500241140	4"(110mm)		

CÓDIGO
DESCUENTO

REGULADOR DE PRESION C/MANOMETRO

MOD. V182/V82, PP / EPDM

	SOLD. TOPE		
	CODIGO	MEDIDA	PRECIO
500241005	½" (20 mm)		
500241007	¾"(25mm)		
500241010	1"(32mm)		
500241012	1¼"(40mm)		
500241015	1½"(50mm)		
500241020	2"(63mm)		
500241025	2½" (75 mm)		
500241030	3"(90mm)		
500241040	4"(110mm)		

CÓDIGO
DESCUENTO

REGULADOR DE PRESION, HIGH PERFORMANCE

MOD. V782, PP / PTFE

	SOLD. TOPE		
	CODIGO	MEDIDA	PRECIO
500243105	½" (20 mm)		
500243107	¾"(25mm)		
500243110	1"(32mm)		
500243112	1¼"(40mm)		
500243115	1½"(50mm)		

CÓDIGO
DESCUENTO

REGULADOR DE PRESION, HIGH PERFORMANCE

MOD. V782, PP / EPDM

	SOLD. TOPE		
	CODIGO	MEDIDA	PRECIO
500243005	½" (20 mm)		
500243007	¾"(25mm)		
500243010	1"(32mm)		
500243012	1¼"(40mm)		
500243015	1½"(50mm)		

CÓDIGO
DESCUENTO

REGULADOR DE PRESION "BACK PRESSURE"

MOD. V186/86, PP / EPDM

	SOLD. TOPE		
	CODIGO	MEDIDA	PRECIO
500244005	½" (20 mm)		
500244007	¾"(25mm)		
500244010	1"(32mm)		
500244012	1¼"(40mm)		
500244015	1½"(50mm)		
500244020	2"(63mm)		
500244025	2½" (75 mm)		
500244030	3"(90mm)		
500244040	4"(110mm)		

CÓDIGO
DESCUENTO

REGULADOR DE PRESION "BACK PRESSURE"

MOD. V186/86, PP / PTFE

	SOLD. TOPE		
	CODIGO	MEDIDA	PRECIO
500244105	½" (20 mm)		
500244107	¾"(25mm)		
500244110	1"(32mm)		
500244112	1¼"(40mm)		
500244115	1½"(50mm)		
500244120	2"(63mm)		
500244125	2½" (75 mm)		
500244130	3"(90mm)		
500244140	4"(110mm)		

CÓDIGO
DESCUENTO

REGULADOR DE PRESION, HIGH PERFORMANCE

MOD. V782, PP / PTFE, "BACK PRESSURE"

	SOLD. TOPE		
	CODIGO	MEDIDA	PRECIO
500249105	½" (20 mm)		
500249107	¾"(25mm)		
500249110	1"(32mm)		
500249112	1¼"(40mm)		
500249115	1½"(50mm)		

CÓDIGO
DESCUENTO

REGULADOR DE PRESION, HIGH PERFORMANCE

MOD. V782, PP / EPDM, "BACK PRESSURE"

	SOLD. TOPE		
	CODIGO	MEDIDA	PRECIO
500249005	½" (20 mm)		
500249007	¾"(25mm)		
500249010	1"(32mm)		
500249012	1¼"(40mm)		
500249015	1½"(50mm)		

CÓDIGO
DESCUENTO



VALVULA DE ALIVIO DE PRESION

MOD. V185/85, PP / EPDM

CÓDIGO
DESCUENTO

	SOLD. TOPE		PRECIO
	CODIGO	MEDIDA	
	500245005	½" (20 mm)	
	500245007	¾"(25mm)	
	500245010	1"(32mm)	
	500245012	1¼"(40mm)	
	500245015	1½"(50mm)	
	500245020	2"(63mm)	
	500245025	2½" (75 mm)	
	500245030	3"(90mm)	
	500245040	4"(110mm)	

VALVULA DE ALIVIO DE PRESION

MOD. V185/85, PP / PTFE

CÓDIGO
DESCUENTO

	SOLD. TOPE		PRECIO
	CODIGO	MEDIDA	
	500245105	½" (20 mm)	
	500245107	¾"(25mm)	
	500245110	1"(32mm)	
	500245112	1¼"(40mm)	
	500245115	1½"(50mm)	
	500245120	2"(63mm)	
	500245125	2½" (75 mm)	
	500245130	3"(90mm)	
	500245140	4"(110mm)	

VÁLVULA DE ALIVIO DE PRESION, PP / EPDM

ROSCAR

CÓDIGO
DESCUENTO

	ROSCAR		PRECIO
	CODIGO	MEDIDA	
	1363005	½"	
	1363007	¾"	
	1363010	1"	

VÁLVULA DE ALIVIO DE PRESION, PP / EPDM

BRIDADA

CÓDIGO
DESCUENTO

	BRIDADA		PRECIO
	CODIGO	MEDIDA	
	1362005	½"	
	1362007	¾"	
	1362010	1"	
	1362015	1½"	
	1362020	2"	
	1362030	3"	
	1362040	4"	



NOTAS: PARA FILTROS DE CANASTA

- 1.- PARA 1/2", 3/4", Y 1" LA PERFORACION ESTANDAR ES 1/32"
- 2.- PARA 1 1/2" HASTA 8" PERFORACION ESTANDAR ES 1/8"

FILTRO CANASTA SIMPLEX, CPVC CORZAN / VITON



CEMENTAR / ROSCAR

CODIGO	MEDIDA	PRECIO
SB2050ST	1/2"	
SB2075ST	3/4"	
SB2100ST	1"	
SB2125ST	1 1/4"	
SB2150ST	1 1/2"	
SB2200ST	2"	

BRIDA

CODIGO	MEDIDA	PRECIO
SB2050F	1/2"	
SB2075F	3/4"	
SB2100F	1"	
SB2125F	1 1/4"	
SB2150F	1 1/2"	
SB2200F	2"	
SB2250F	2 1/2"	
SB2300F	3"	
SB2400F	4"	
SB2600FT	6"	
SB2800FT	8"	

ROSCAR

CODIGO	MEDIDA	PRECIO
SB2250T	2 1/2"	
SB2300T	3"	
SB2400T	4"	

CÓDIGO
DESCUENTO

CANASTA DE REPUESTO



MESH 20

CODIGO	MEDIDA	PRECIO
BS710020	1/2" - 1"	
BS720020	1 1/4" - 2"	
BS740020	2 1/2" - 4"	
BS760020	6"	
BS780020	8"	

MESH 40

CODIGO	MEDIDA	PRECIO
BS710040	1/2" - 1"	
BS720040	1 1/4" - 2"	
BS740040	2 1/2" - 4"	
BS760040	6"	
BS780040	8"	

MESH 60

CODIGO	MEDIDA	PRECIO
BS710060	1/2" - 1"	
BS720060	1 1/4" - 2"	
BS740060	2 1/2" - 4"	
BS760060	6"	
BS780060	8"	

MESH 80

CODIGO	MEDIDA	PRECIO
BS710080	1/2" - 1"	
BS720080	1 1/4" - 2"	
BS740080	2 1/2" - 4"	
BS760080	6"	
BS780080	8"	

MESH 100

CODIGO	MEDIDA	PRECIO
BS7100100	1/2" - 1"	
BS7200100	1 1/4" - 2"	
BS7400100	2 1/2" - 4"	
BS7600100	6"	
BS7800100	8"	

CÓDIGO
DESCUENTO

FILTRO CANASTA SIMPLEX, CPVC CORZAN / EPDM



CEMENTAR / ROSCAR

CODIGO	MEDIDA	PRECIO
SB2050STE	1/2"	
SB2075STE	3/4"	
SB2100STE	1"	
SB2125STE	1 1/4"	
SB2150STE	1 1/2"	
SB2200STE	2"	

BRIDA

CODIGO	MEDIDA	PRECIO
SB2050FE	1/2"	
SB2075FE	3/4"	
SB2100FE	1"	
SB2125FE	1 1/4"	
SB2150FE	1 1/2"	
SB2200FE	2"	
SB2250FE	2 1/2"	
SB2300FE	3"	
SB2400FE	4"	
SB2600FTE	6"	
SB2800FTE	8"	

ROSCAR

CODIGO	MEDIDA	PRECIO
SB2250TE	2 1/2"	
SB2300TE	3"	
SB2400TE	4"	

CÓDIGO
DESCUENTO

FILTRO CANASTA DUPLEX, CPVC CORZAN / VITON



CEMENTAR / ROSCAR

CODIGO	MEDIDA	PRECIO
DB2050ST	1/2"	
DB2075ST	3/4"	
DB2100ST	1"	
DB2125ST	1 1/4"	
DB2150ST	1 1/2"	
DB2200ST	2"	

BRIDA

CODIGO	MEDIDA	PRECIO
DB2050F	1/2"	
DB2075F	3/4"	
DB2100F	1"	
DB2125F	1 1/4"	
DB2150F	1 1/2"	
DB2200F	2"	
DB2250F	2 1/2"	
DB2300F	3"	
DB2400F	4"	
DB2600FT	6"	
DB2800FT	8"	

ROSCAR

CODIGO	MEDIDA	PRECIO
DB2250T	2 1/2"	
DB2300T	3"	
DB2400T	4"	

CÓDIGO
DESCUENTO



CANASTA REPUESTO SIMPLEX / DUPLEX
CPVC CORZAN

PARA 1/2", 3/4", Y 1"		
CODIGO	MEDIDA	PRECIO
BS21001/32	1/32"	
BS21001/16	1/16"	
BS21001/8	1/8"	
BS21003/16	3/16"	

PARA 1 1/4", 1 1/2", Y 2"		
CODIGO	MEDIDA	PRECIO
BS22001/32	1/32"	
BS22001/16	1/16"	
BS22001/8	1/8"	
BS22003/16	3/16"	

PARA 2 1/2", 3", Y 4"		
CODIGO	MEDIDA	PRECIO
BS24001/32	1/32"	
BS24001/16	1/16"	
BS24001/8	1/8"	
BS24003/16	3/16"	

PARA 6"		
CODIGO	MEDIDA	PRECIO
BS26001/32	1/32"	
BS26001/16	1/16"	
BS26001/8	1/8"	
BS26003/16	3/16"	

PARA 8"		
CODIGO	MEDIDA	PRECIO
BS28001/32	1/32"	
BS28001/16	1/16"	
BS28001/8	1/8"	
BS28003/16	3/16"	

FILTRO YEE DOBLE UNION CPVC CORZAN / VITON

ROSCAR		
CODIGO	MEDIDA	PRECIO
YS20050TU	1/2"	
YS20075TU	3/4"	
YS20100TU	1"	
YS20150TU	1 1/2"	
YS20200TU	2"	
YS20300TU	3"	
YS20400TU	4"	

FILTRO BOLSA SIMPLEX PP, ROSCAR (R), BRIDA (F)

LARGO SIMPLE 16"		
CODIGO	MEDIDA	PRECIO
FLT4201	2"	R
FLT4201F	2"	F

LARGO DOBLE 32"		
CODIGO	MEDIDA	PRECIO
FLT4202	2"	R
FLT4202F	2"	F

FILTRO CANASTA DUPLEX, CPVC CORZAN / VITON

CEMENTAR / ROSCAR		
CODIGO	MEDIDA	PRECIO
DB2050STE	1/2"	
DB2075STE	3/4"	
DB2100STE	1"	
DB2125STE	1 1/4"	
DB2150STE	1 1/2"	
DB2200STE	2"	

BRIDA		
CODIGO	MEDIDA	PRECIO
DB2050FE	1/2"	
DB2075FE	3/4"	
DB2100FE	1"	
DB2125FE	1 1/4"	
DB2150FE	1 1/2"	
DB2200FE	2"	
DB2250FE	2 1/2"	
DB2300FE	3"	
DB2400FE	4"	
DB2600FE	6"	
DB2800FE	8"	

ROSCAR		
CODIGO	MEDIDA	PRECIO
DB2250TE	2 1/2"	
DB2300TE	3"	
DB2400TE	4"	

CEDAZO PLASTICO PARA FILTROS YEE CPVC CORZAN
PERFORACION DE 1/32"

CODIGO	MEDIDA	PRECIO
YSX2005022	1/2"	
YSX2007522	3/4"	
YSX2010022	1"	
YSX2015022	1 1/2"	
YSX2020022	2"	
YSX2030022	3"	
YSX2040022	4"	

FILTRO BOLSA DUPLEX BRIDADO, PP/VITON
CON VALVULAS DE CPVC CORZAN

LARGO DOBLE 32"		
CODIGO	MEDIDA	PRECIO
FLT2DUPA	2"	

FILTROS BOLSA EN PARALELO (MANIFOLD), BRIDADC
PP/VITON, VALV. CPVC CORZAN

LARGO SIMPLE 16"		
CODIGO	MEDIDA	PRECIO
FLT1TRI3	3 X 3"	

LARGO DOBLE 32"		
CODIGO	MEDIDA	PRECIO
FLT2TRI4	3 X 4"	
FLT2QAD3*	4 X 3"	
FLT2QAD4*	4 X 4"	



**CEDAZO PLASTICO PARA FILTROS YEE CPVC CORZAN
REFUERZO DE ACERO INOX**

**CÓDIGO
DESCUENTO**

MESH 20		
CODIGO	MEDIDA	PRECIO
YS2705020	1/2"	
YS2707520	3/4"	
YS2710020	1"	
YS2712520	1 1/4"	
YS2715020	1 1/2"	
YS2720020	2"	
YS2730020	3"	
YS2740020	4"	

MESH 40		
CODIGO	MEDIDA	PRECIO
YS2705040	1/2"	
YS2707540	3/4"	
YS2710040	1"	
YS2715040	1 1/4"	
YS2715040	1 1/2"	
YS2720040	2"	
YS2730040	3"	
YS2740040	4"	

MESH 60		
CODIGO	MEDIDA	PRECIO
YS2705060	1/2"	
YS2707560	3/4"	
YS2710060	1"	
YS2715060	1 1/4"	
YS2715060	1 1/2"	
YS2720060	2"	
YS2730060	3"	
YS2740060	4"	

MESH 80		
CODIGO	MEDIDA	PRECIO
YS2705080	1/2"	
YS2707580	3/4"	
YS2710080	1"	
YS2715080	1 1/4"	
YS2715080	1 1/2"	
YS2720080	2"	
YS2730080	3"	
YS2740080	4"	

**CEDAZO PLASTICO PARA FILTROS YEE CPVC CORZAN
REFUERZO DE ACERO INOX**

~.hDig~

**CÓDIGO
DESCUENTO**

MESH 100		
CODIGO	MEDIDA	PRECIO
YS27050100	1/2"	
YS27075100	3/4"	
YS27100100	1"	
YS27150100	1 1/4"	
YS27150100	1 1/2"	
YS27200100	2"	
YS27300100	3"	
YS27400100	4"	

MESH 200		
CODIGO	MEDIDA	PRECIO
YS27050200	1/2"	
YS27075200	3/4"	
YS27100200	1"	
YS27150200	1 1/4"	
YS27150200	1 1/2"	
YS27200200	2"	
YS27300200	3"	
YS27400200	4"	

MESH 325		
CODIGO	MEDIDA	PRECIO
YS27050325	1/2"	
YS27075325	3/4"	
YS27100325	1"	
YS27150325	1 1/4"	
YS27150325	1 1/2"	
YS27200325	2"	
YS27300325	3"	
YS27400325	4"	



FILTRO BOLSA PP - FUNDIDO
ARO PLASTICO SENTINEL



LARGO SIMPLE 16", CAJA DE 50		
CODIGO	MEDIDA	PRECIO
F31R36590	1 MICRON	
F31R36817	5 MICRON	
F31R36552	10 MICRON	
F31R36596	25 MICRON	
F31R36589	50 MICRON	
F31R36551	100 MICRON	
F3AB00319	200 MICRON	

CÓDIGO
DESCUENTO



LARGO DOBLE 32", CAJA DE 30		
CODIGO	MEDIDA	PRECIO
F31S36502	1 MICRON	
F31S36501	5 MICRON	
F31S36503	10 MICRON	
F31S36412	25 MICRON	
F31S36500	50 MICRON	
F31S36505	100 MICRON	
F3AB00222	200 MICRON	

FILTROS BOLSA PP MONOFILAMENTO - COSIDO



LARGO SIMPLE 16", CAJA DE 50		
CODIGO	MEDIDA	PRECIO
F3AB00170	150 MICRON	
F3AB00173	400 MICRON	
F3AB00174	600 MICRON	
F3AB00175	800 MICRON	

CÓDIGO
DESCUENTO



LARGO DOBLE 32", CAJA DE 50		
CODIGO	MEDIDA	PRECIO
F3AB00177	150 MICRON	
F3AB00180	400 MICRON	
F3AB00181	600 MICRON	
F3AB00182	800 MICRON	

FILTRO BOLSA PP - ARO COSIDO



LARGO SIMPLE 16", CAJA DE 50		
CODIGO	MEDIDA	PRECIO
F3AB00013	1 MICRON	
F3AB00157	5 MICRON	
F3AB00019	10 MICRON	
F3AB00020	25 MICRON	
F3AB00014	50 MICRON	
F31A37288	100 MICRON	
F3AB00103	200 MICRON	

CÓDIGO
DESCUENTO

LARGO DOBLE 32", CAJA DE *		
CODIGO	MEDIDA	PRECIO
F31B36372	1 MICRON	30
F31B37455	5 MICRON	50
F3AA01434	10 MICRON	50
F3AB00002	25 MICRON	50
F3AA00160	50 MICRON	50
F3AA01128	100 MICRON	50
F3AB00057	200 MICRON	30

* CAJA

MANOMETRO DE PRESION DIFERENCIAL



ALUMINIO / NYLON		
CODIGO	MEDIDA	PRECIO
FLTDPAL		

CÓDIGO
DESCUENTO



SS / PTFE		
CODIGO	MEDIDA	PRECIO
FLTDPSS		

SWITCH DIFERENCIAL DE PRESION



CODIGO	MEDIDA	PRECIO
FLTDPSW		

CÓDIGO
DESCUENTO

EQUIPOS TERMOFUSION



VENTA

SHOP 4 MINIPLAST PARA FUSION A TOPE DE 110V



CODIGO	MEDIDA	PRECIO
5730000	20-110MM	

SHOP 12 W25000 PARA FUSION A TOPE DE 110V



CODIGO	MEDIDA	PRECIO
5722000	50-315 MM	

RENTA

SHOP 4 MINIPLAST PARA FUSION A TOPE DE 110V



CODIGO	PRECIO
9730000-2	SEMANAL
9730000-3	MENSUAL

SHOP 12 W25000 PARA FUSION A TOPE DE 110V



CODIGO	PRECIO
9722000-2	SEMANAL
9722000-3	MENSUAL

PARA RENTA SE DEBE FIRMAR CONTRATO
RENTA DIARIA, COTIZAR POR EVENTO

ACCESORIOS



CORTADOR MANUAL DE TUBERÍA



CODIGO	MEDIDA	PRECIO
790109001	16-63MM	
790109002	50-110MM	
790109003	110-160MM	

RUEDA DE REPUESTO



CODIGO	MEDIDA	PRECIO
790109011	16-63MM	
790109012	50-110MM	
790109013	110-160MM	

E-CTFE (HALAR) / PVDF (KYNAR)

Pág. E-CTFE (HALAR) / PVDF (KYNAR)

- 46** ▶ Tubería de E-CTFE (HALAR)
- 47** ▶ Tubería de PVDF (KYNAR)
- 48** ▶ Conexión de PVDF (KYNAR) Soldadura a Tope (Butt)
 - * RD-21
 - * RD-33
 - * Accesorios (Aro para Bridas, Empaques y Soporte de Tubería)
- 55** ▶ Conexión de PVDF (KYNAR) Soldadura a Caja (Socket)
 - * RD-21
- 56** ▶ Válvulas
 - * Bola y 3 Vías
 - * Mariposa Operador Palanca, Engrane y Tipo Lug
 - * Diafragma Manual y Neumático
 - * Check Bola, Columpio y Wafer
 - * Globo y Globo de Control
 - * Protector de Manómetro (Sello Químico)
- 65** ▶ Reguladores de Presión
- 66** ▶ Filtros Bolsa
- 67** ▶ Equipos de Termofusión

CORRELACION SDR Y PRESION NOMINAL (PN) PARA E-CTFE

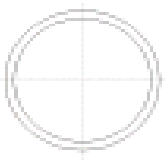

DIAM. (mm)	DIAM. APROX PULG.
16	3/8
20	1/2
25	3/4
32	1
40	1 1/4
50	1 1/2
63	2
75	2 1/2
90	3
110	4
160	6
200	8
225	9
250	10
315	12
355	14
400	16

SDR	PN (BAR)	PSI
21	10	145.03

NOTAS:
 1.- FACTOR DE SEGURIDAD 2.5
 2.- VALORES REMETIDOS A 20°C Y VIDA UTIL DE 50 ANOS, PARA CONEXIÓN INYECTADA.

TUBERIA E-CTFE, RD 21



CÓDIGO	MEDIDA	PRECIO
010002746	16 mm	
010002747	20 mm	
010002748	25 mm	
010002749	32 mm	
010002750	40 mm	
010002751	50 mm	
010002752	63 mm	
010002753	75 mm	
010002754	90 mm	
010002755	110 mm	
010002756	125 mm	
010002757	140 mm	
010002758	160 mm	

CÓDIGO

DESCUENTO

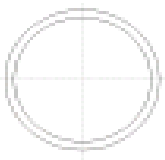
TRAMOS DE 5 MTS



DIAM. (mm)	DIAM. APROX.
16	3/8"
20	1/2"
25	3/4"
32	1"
40	1 1/4"
50	1 1/2"
63	2"
75	2 1/2"
90	3"
110	4"
160	6"
200	8"
225	9"
250	10"
315	12"
355	14"
400	16"

CORRELACION SDR Y PRESION NOMINAL (PN) PARA PVDF

SDR	PN (BAR)	PSI
21	16	232.06
33	10	145.03

NOTAS:
 1.- FACTOR DE SEGURIDAD 2
 2.- VALORES REMETIDOS A 20°C Y VIDA UTIL DE 50 ANOS, PARA CONEXIÓN INYECTADA.

TUBERIA PVDF RD 21



CÓDIGO	MEDIDA	PRECIO
010000956	16 mm	
010000957	20 mm	
010000958	25 mm	
010000959	32 mm	
010000960	40 mm	
010000961	50 mm	
010000963	63 mm	
010000965	75 mm	
010000967	90 mm	
010000969	110 mm	
010002153	125 mm	
010002154	140 mm	
010002155	160 mm	

CÓDIGO DESCUENTO

TUBERIA PVDF RD 33



CÓDIGO	MEDIDA	PRECIO
010000962	63 mm	
010000964	75 mm	
010000966	90 mm	
010000968	110 mm	
010000970	125 mm	
010000971	140 mm	
010000972	160 mm	
010000973	180 mm	
010000974	200 mm	
010001128	225 mm	
010002160	250 mm	
010002161	280 mm	
010002162	315 mm	

CÓDIGO DESCUENTO

TUBERIA PVDF PARA LINER CON TRATAMIENTO



CÓDIGO	MEDIDA	PRECIO
010000985	32 mm	
010000986	40 mm	
010000987	50 mm	
010000988	63 mm	
010000989	75 mm	
010000990	90 mm	
010000991	110 mm	
010000992	125 mm	
010000993	160mm	
010000994	200mm	
010000995	250mm	
010001241	280mm	
010000996	315mm	
010000997	355mm	
010000998	400mm	

CÓDIGO DESCUENTO

TUBERIA PVDF PARA LINER SIN TRATAMIENTO



CÓDIGO	MEDIDA	PRECIO
010001239	75 mm	
010000976	90 mm	
010000977	110 mm	
010000978	125 mm	
010000979	160mm	
010000980	200mm	
010000981	250mm	
010001240	280mm	
010000982	315mm	
010000983	355mm	
010000984	400mm	

CÓDIGO DESCUENTO

CODO 90° RADIO LARGO PVDF, EXT LARGOS RD 21



CODIGO	MEDIDA	PRECIO
010102954	75 mm	
010102938	90 mm	
010102940	110 mm	
010102944	140 mm	
010102946	160 mm	
010102948	200 mm	
010102950	225 mm	

CODO 90° PVDF, EXT LARGOS RD 21



CÓDIGO	MEDIDA	PRECIO
010200246	20 mm	
010200247	25 mm	
010200248	32 mm	
010200249	40 mm	
010200250	50 mm	
010200251	63 mm	

CODO 45° PVDF, EXT LARGOS RD 21



CÓDIGO	MEDIDA	PRECIO
010200252	20 mm	
010200253	25 mm	
010200254	32 mm	
010200255	40 mm	
010200256	50 mm	
010200257	63 mm	
010200258	75 mm	
010200259	90 mm	
010200260	110 mm	
010200261	140 mm	
010200262	160 mm	
010200263	200 mm	
010200264	225 mm	

CODO 90° RADIO LARGO PVDF, EXT CORTOS RD 21



CÓDIGO	MEDIDA	PRECIO
010100513	20 mm	
010100514	25 mm	
010100515	32 mm	
010100516	40 mm	
010100517	50 mm	
010100518	63 mm	

**STUB END PVDF (PORTABRIDA) ANSI
EXT LARGOS RD 21**



CODIGO	MEDIDA	PRECIO
019400216	25 mm	
019400217	32 mm	
019400218	40 mm	
019400219	50 mm	
019400222	63 mm	

**STUB END PVDF (PORTABRIDA) ISO/DIN
EXT LARGOS RD 21**



CODIGO	MEDIDA	PRECIO
010600942	20 mm	
010600943	25 mm	
010600944	32 mm	
010600945	40 mm	
010600946	50 mm	
010600947	63 mm	
010600948	75 mm	
010600950	90 mm	
010600952	110 mm	
010600955	140 mm	
010600957	160 mm	
010600959	200 mm	
010600961	225 mm	

TEE PVDF, EXT LARGOS RD 21



CODIGO	MEDIDA	PRECIO
010300957	20 mm	
010300958	25 mm	
010300959	32 mm	
010300960	40 mm	
010300961	50 mm	
010300962	63 mm	
010300963	75 mm	
010300965	90 mm	
010300967	110 mm	
010300983	140 mm	
010300985	160 mm	
010300986	200 mm	
010300988	225 mm	

TEE REDUCIDA PVDF, EXT LARGOS RD 21



CODIGO	MEDIDA	PRECIO
010006377	160/90 mm	
010006378	160/110 mm	
010006379	225/90 mm	
010006380	225/110 mm	

TUERCA UNION PVDF/FPM, EXT LARGOS RD 21



CODIGO	MEDIDA	PRECIO
019500033	20 mm	
019500034	25 mm	
019500035	32 mm	
019500036	40 mm	
019500037	50 mm	
019500038	63 mm	

CODIGO
DESCUENTO

REDUCCION CONCENTRICA PVDF, EXT LARGOS RD 21



CODIGO	MEDIDA	PRECIO
014901346	25/20 mm	
014901348	32/20 mm	
014901347	32/25 mm	
014901351	40/20 mm	
014901350	40/25 mm	
014901349	40/32 mm	
014901401	50/25 mm	
014901400	50/32 mm	
014901399	50/40 mm	
014901404	63/32 mm	
014901403	63/40 mm	
014901402	63/50 mm	
014901407	75/40 mm	
014901406	75/50 mm	
014901405	75/63 mm	
014901422	90/63 mm	
014901408	90/75 mm	
014901423	110/63 mm	
014901411	110/75 mm	
014901410	110/90 mm	
014901413	140/110 mm	
014901415	160/110 mm	
010005986	160/140 mm	
014901352	200/160 mm	
014901353	225/110 mm	
014901354	225/160 mm	
014901355	225/200 mm	

CODIGO
DESCUENTO

**ADAPTADOR HEMBRA ROSCA NPT PVDF
EXT LARG RD 21**



CODIGO	MEDIDA	PRECIO
019900025	20 X 1/2"	
019900026	25 X 3/4"	
019900027	32 X 1"	
019900028	40 X 1 1/4"	
019900029	50 X 1 1/2"	
019900030	63 X 2"	

CODIGO
DESCUENTO

**ADAPTADOR MACHO ROSCA NPT PVDF
EXT LARG RD 21**



CODIGO	MEDIDA	PRECIO
020000019	20 X 1/2"	
020000020	25 X 3/4"	
020000021	32 X 1"	
020000022	40 X 1 1/4"	
020000023	50 X 1 1/2"	
020000024	63 X 2"	

CODIGO
DESCUENTO

CODO 45° PVDF, EXT LARGOS RD 33



CODIGO	MEDIDA	PRECIO
010200265	90 mm	
010200266	110 mm	
010200267	125 mm	
010200268	140 mm	
010200269	160 mm	
010200270	200 mm	
010200271	225 mm	

CODO 90° RADIO LARGO PVDF, EXT LARGOS RD 33



CÓDIGO	MEDIDA	PRECIO
010102937	90 mm	
010102939	110 mm	
010102941	125 mm	
010102943	140 mm	
010102945	160 mm	
010102947	200 mm	
010102949	225 mm	

TEE PVDF, EXT LARGOS RD 33



CODIGO	MEDIDA	PRECIO
010300964	90 mm	
010300966	110 mm	
010300981	125 mm	
010300982	140 mm	
010300984	160 mm	
010300993	200 mm	
010300987	225 mm	

TEE REDUCIDA PVDF, EXT LARGOS RD 33



CODIGO	MEDIDA	PRECIO
010006283	160/90 mm	
010006284	160/110 mm	
010006285	225/90 mm	
010006286	225/110 mm	

REDUCCION CONCENTRICA PVDF, EXT LARGOS RD 33



CODIGO	MEDIDA	PRECIO
010006524	90/63 mm	
010006525	110/63 mm	
014901418	110/90 mm	
010006521	125/110 mm	
010006522	140/110 mm	
014901419	140/125 mm	
014901420	160/110 mm	
010006523	160/110 mm	
014901421	160/140 mm	
014901342	200/160 mm	
010006520	225/110 mm	
014901343	225/110 mm	
014901344	225/160 mm	
014901345	225/200 mm	

**STUB END PVDF (PORTABRIDA) ISO/DIN
EXT LARGOS RD 33**



CODIGO	MEDIDA	PRECIO
010600949	90 mm	
010600951	110 mm	
010600953	125 mm	
010600954	140 mm	
010600956	160 mm	
010600958	200 mm	
010600960	225 mm	

**EMPAQUE PERFILADO CON NUCLEO DE ACERO
FPM RD 33**



CODIGO	MEDIDA	PRECIO
017000054	90 mm	
017000055	110 mm	
017000056	125 mm	
017000057	140 mm	
017000058	160 mm	
017000059	200 mm	
017000060	225 mm	
017000061	250 mm	
017000062	280 mm	
017000063	315 mm	

ARO PARA BRIDA ACERO/PP-HG, ISO/DIN RD 11, NEGRO



CÓDIGO	MEDIDA	PRECIO
013000021	20 mm	
013000022	25 mm	
013000023	32 mm	
013000024	40 mm	
013000025	50 mm	
013000026	63 mm	
013000027	75 mm	
013000028	90 mm	
013000029	110 mm	
013000030	125 mm	
013000031	140 mm	
013000032	160 mm	
013000033	180 mm	

ARO PARA BRIDA ACERO/PP-HG, ISO/DIN RD 17, NEGRO



CÓDIGO	MEDIDA	PRECIO
013000034	200 mm	
013000035	225 mm	
013000036	250 mm	
013000037	280 mm	
013000038	315 mm	
013000039	355 mm	
013000040	400 mm	
013000041	450 mm	
013000042	500 mm	

ARO PARA BRIDA ACERO/PP-HG, ANSI 150 lbs, GRIS



CÓDIGO	MEDIDA	PRECIO
013000047	½" (20 mm)	
013000048	¾" (25 mm)	
013000049	1" (32 mm)	
013000050	1¼" (40 mm)	
013000051	1½" (50 mm)	
013000052	2" (63 mm)	
013000053	2½" (75 mm)	
013000054	3" (90 mm)	
013000055	4" (110 mm)	
013000056	6" (160 mm)	
013000057	8" (200 mm)	
013000058	10" (250 mm)	
013000059	12" (315 mm)	
013000074	14" (355 mm)	
013000209	16" (400 mm)	

EMPAQUE PARA BRIDA, FPM RD 21



CODIGO	MEDIDA	PRECIO
016900037	20 mm	
016900038	25 mm	
016900039	32 mm	
016900040	40 mm	
016900041	50 mm	
016900042	63 mm	
016900043	75 mm	
016900044	90 mm	
016900045	110 mm	

EMPAQUE PERFILADO ACERO/FPM RD 21



CODIGO	MEDIDA	PRECIO
017000064	25 mm	
017000065	32 mm	
017000066	40 mm	
017000067	50 mm	
017000068	63 mm	
017000069	75 mm	
017000070	90 mm	
017000071	110 mm	
017000072	140 mm	
017000073	160 mm	
017000074	200 mm	
017000075	225 mm	

BRIDA CIEGA ACERO/PP-HG, ISO/DIN RD 11



CODIGO	MEDIDA	PRECIO
013100003	20 mm	
013100004	25 mm	
013100005	32 mm	
013100006	40 mm	
013100007	50 mm	
013100008	63 mm	
013100009	75 mm	
013100010	90 mm	
013100011	110 mm	
013100012	125 mm	
013100013	140 mm	
013100014	160 mm	
013100015	180 mm	

BRIDA CIEGA ACERO/PP-HG, ISO/DIN RD 17



CODIGO	MEDIDA	PRECIO
013100016	200 mm	
013100017	225 mm	
013100018	250 mm	
013100019	280 mm	
013100020	315 mm	
013100021	355 mm	
013100022	400 mm	

EMPAQUE EPDM RD 11



CODIGO	MEDIDA	PRECIO
016900015	20 mm	
016900034	25 mm	
016900016	32 mm	
016900017	40 mm	
016900018	50 mm	
016900019	63 mm	
016900020	75 mm	
016900021	90 mm	
016900022	110 mm	
016900023	125 mm	
016900024	140 mm	
016900025	160 mm	
016900026	180 mm	
016900027	200 mm	
016900028	225 mm	
016900029	250 mm	
016900030	280 mm	
016900031	315 mm	
016900032	355 mm	
016900033	400 mm	
016900046	450 mm	
016900082	500 mm	
016900083	560 mm	
016900078	630 mm	

EMPAQUE EPDM RD 17 Y 17.6



CODIGO	MEDIDA	PRECIO
016900047	50 mm	
016900048	63 mm	
016900049	75 mm	
016900050	90 mm	
016900051	110 mm	
016900052	125 mm	
016900053	140 mm	
016900054	160 mm	
016900055	180 mm	
016900056	200 mm	
016900057	225 mm	
016900058	250 mm	
016900059	280 mm	
016900060	315 mm	
016900061	355 mm	
016900062	400 mm	
016900084	450 mm	
016900087	500 mm	
016900088	560 mm	
016900089	630 mm	
016900090	710 mm	
016900091	800 mm	
016900092	900 mm	
016900093	1000 mm	

EMPAQUE PERFILADO ACERO/EPDM RD 17



CODIGO	MEDIDA	PRECIO
017000034	50 mm	
017000035	63 mm	
017000036	75 mm	
017000037	90 mm	
017000038	110 mm	
017000039	125 mm	
017000040	140 mm	
017000041	160 mm	
017000042	180 mm	
017000043	200 mm	
017000044	225 mm	
017000045	250 mm	
017000046	280 mm	
017000047	315 mm	
017000048	355 mm	
017000049	400 mm	
017000050	450 mm	
017000051	500 mm	
017000023	560 mm	
017000052	630 mm	

EMPAQUE PERFILADO ACERO/EPDM RD 11



CODIGO	MEDIDA	PRECIO
017000004	25 mm	
017000005	32 mm	
017000006	40 mm	
017000007	50 mm	
017000008	63 mm	
017000009	75 mm	
017000001	90 mm	
017000010	110 mm	
017000011	125 mm	
017000012	140 mm	
017000013	160 mm	
017000002	180 mm	
017000014	200 mm	
017000015	225 mm	
017000003	250 mm	
017000016	280 mm	
017000017	315 mm	
017000018	355 mm	
017000019	400 mm	
017000020	450 mm	
017000021	500 mm	
017000022	560 mm	
017000053	630 mm	

EMPAQUE PERFILADO FPM RD 11



CODIGO	MEDIDA	PRECIO
01700091	25 mm	
01700092	32 mm	
01700093	40 mm	
01700094	50 mm	
01700095	63 mm	
01700096	75 mm	
01700097	90 mm	
01700098	110 mm	
01700099	125 mm	
01700100	140 mm	
01700101	160 mm	
01700102	180 mm	
01700103	200 mm	
01700104	225 mm	
01700105	250 mm	
01700106	280 mm	
01700107	315 mm	
01700108	355 mm	
01700090	400 mm	



EMPAQUE PERFILADO ACERO/EPDM RD 33



CODIGO	MEDIDA	PRECIO
01700025	110 mm	
01700024	125 mm	
01700026	140 mm	
01700027	160 mm	
01700028	180 mm	
01700029	200 mm	
01700030	225 mm	
01700031	250 mm	
01700032	280 mm	
01700033	315 mm	



EMPAQUE PERFILADO FPM RD 17



CODIGO	MEDIDA	PRECIO
01700076	63 mm	
01700077	75 mm	
01700078	90 mm	
01700079	110 mm	
01700080	125 mm	
01700081	140 mm	
01700082	160 mm	
01700083	180 mm	
01700084	200 mm	
01700085	225 mm	
01700086	250 mm	
01700087	280 mm	
01700088	315 mm	
01700089	355 mm	
01700128	400 mm	



ESPACIADOR PARA ABRAZADERA



CODIGO	MEDIDA	PRECIO
02380014	16 mm	
02380015	20 mm	
02380016	25 mm	
02380017	32 mm	
02380018	40 mm	
02380019	50 mm	
02380020	63 mm	
02380021	75 mm	
02380022	90 mm	
02380023	110 mm	
02380024	125 mm	
02380025	140 mm	
02380026	160 mm	



EMPAQUE PERFILADO FPM, SOLDADURA SOCKET



CODIGO	MEDIDA	PRECIO
017000129	16 mm	
017000109	20 mm	
017000110	25 mm	
017000111	32 mm	
017000112	40 mm	
017000113	50 mm	
017000114	63 mm	
017000115	75 mm	
017000116	90 mm	
017000117	110 mm	



EMPAQUES PARA BRIDA (BAJO TORQUE)



EPDM, ANSI B16.5

CÓDIGO	MEDIDA	PRECIO
3113005	1/2"	
3113007	3/4"	
3113010	1"	
3113012	1 1/4"	
3113015	1 1/2"	
3113020	2"	
3113025	2 1/2"	
3113030	3"	
3113040	4"	
3113060	6"	
3113080	8"	
3113100	10"	
3113120	12"	



EMPAQUE PERFILADO EPDM, SOLDADURA SOCKET



CODIGO	MEDIDA	PRECIO
017000118	16 mm	
017000119	20 mm	
017000120	25 mm	
017000121	32 mm	
017000122	40 mm	
017000123	50 mm	
017000124	63 mm	
017000125	75 mm	
017000126	90 mm	
017000127	110 mm	



EMPAQUES PARA BRIDA (BAJO TORQUE)



EPDM CUBIERTO DE PVDF



CÓDIGO	MEDIDA	PRECIO
3115005	1/2"	
3115007	3/4"	
3115010	1"	
3115015	1 1/2"	
3115020	2"	
3115030	3"	
3115040	4"	
3115060	6"	
3115080	8"	
3115100	10"	

ABRAZADERAS PP



CODIGO	MEDIDA	PRECIO
023800001	16 mm	
023800002	20 mm	
023800003	25 mm	
023800004	32 mm	

EMPAQUES PARA BRIDA (BAJO TORQUE)



EPDM CUBIERTO DE PTFE



CÓDIGO	MEDIDA	PRECIO
3114005	1/2"	
3114007	3/4"	
3114010	1"	
3114012	1 1/4"	
3114015	1 1/2"	
3114020	2"	
3114025	2 1/2"	
3114030	3"	
3114040	4"	
3114060	6"	
3114080	8"	
3114100	10"	
3114120	12"	

ABRAZADERAS PP CON OPRESOR



CODIGO	MEDIDA	PRECIO
023800005	40 mm	
023800006	50 mm	
023800007	63 mm	
023800008	75 mm	
023800009	90 mm	
023800010	110 mm	
023800011	125 mm	
023800012	140 mm	
023800013	160 mm	

CODO 45° PVDF, SOLD. CAJA RD 21



CODIGO	MEDIDA	PRECIO
010200281	16 mm	
010200282	20 mm	
010200283	25 mm	
010200284	32 mm	
010200285	40 mm	
010200286	50 mm	
010200287	63 mm	

CÓDIGO
DESCUENTO

CODO 90° INYECTADO PVDF, SOLD. CAJA RD 21



CÓDIGO	MEDIDA	PRECIO
010200274	16 mm	
010200275	20 mm	
010200276	25 mm	
010200277	32 mm	
010200278	40 mm	
010200279	50 mm	
010200280	63 mm	

CÓDIGO
DESCUENTO

TEE PVDF, SOLD. CAJA RD 21



CODIGO	MEDIDA	PRECIO
020500052	16 mm	
020500053	20 mm	
020500054	25 mm	
020500055	32 mm	
020500056	40 mm	
020500057	50 mm	
020500058	63 mm	

CÓDIGO
DESCUENTO

COPLE ELECTROSOLDABE PVDF, SOLD. CAJA RD 21



CODIGO	MEDIDA	PRECIO
014200044	16 mm	
014200045	20 mm	
014200046	25 mm	
014200047	32 mm	
014200048	40 mm	
014200049	50 mm	
014200050	63 mm	

CÓDIGO
DESCUENTO

**STUB END (PORTABRIDA) PVDF ANSI
SOLD. CAJA RD 21**



CODIGO	MEDIDA	PRECIO
015600037	20 mm	
015600054	25 mm	
015600038	32 mm	
015600055	40 mm	
015600056	50 mm	
015600039	63 mm	

CÓDIGO
DESCUENTO

**STUB END (PORTABRIDA) PVDF ISO/DIN
SOLD. CAJA RD 21**



CODIGO	MEDIDA	PRECIO
015600028	20 mm	
015600029	25 mm	
015600030	32 mm	
015600031	40 mm	
015600032	50 mm	
015600033	63 mm	
015600035	90 mm	
015600036	110 mm	

CÓDIGO
DESCUENTO

TAPON PVDF, SOL CAJA RD 21



CODIGO	MEDIDA	PRECIO
020600032	16 mm	
020600033	20 mm	
020600034	25 mm	
020600035	32 mm	
020600036	40 mm	
020600037	50 mm	
020600038	63 mm	

CÓDIGO
DESCUENTO

REDUCCION CONCENTRICA PVDF, SOLD. CAJA RD 21



CODIGO	MEDIDA	PRECIO
014901438	25/20 mm	
010006576	32/20 mm	
014901439	32/25 mm	
010006577	40/20 mm	
014901440	40/25 mm	
014901441	40/32 mm	
010006578	50/20 mm	
010006579	50/25 mm	
014901442	50/32 mm	
014901443	50/40 mm	
010006580	63/20 mm	
010006581	63/25 mm	
014901444	63/32 mm	
010006582	63/40 mm	
014901445	63/50 mm	

CÓDIGO
DESCUENTO

UNION PVDF/FPM, SOLD. CAJA RD 21



CODIGO	MEDIDA	PRECIO
010700083	16 mm	
010700084	20 mm	
010700085	25 mm	
010700086	32 mm	
010700087	40 mm	
010700088	50 mm	
010700089	63 mm	

CÓDIGO
DESCUENTO



VALVULA BOLA, T- 21, PVDF / FKM

SOLD. CAJA DIN



CÓDIGO	MEDIDA	PRECIO
1666005	½"(20mm)	
1666007	¾"(25mm)	
1666010	1"(32mm)	
1666012	1¼"(40mm)	
1666015	1½"(50mm)	
1666020	2"(63mm)	
1666025	2½"(75mm)	
1666030	3"(90mm)	
1666040	4"(110mm)	



VALVULA BOLA, T- 21, PVDF / FKM

ROSCAR



CÓDIGO	MEDIDA	PRECIO
1627005	½"	
1627007	¾"	
1627010	1"	
1627012	1¼"	
1627015	1½"	
1627020	2"	
1627025	2½"	
1627030	3"	
1627040	4"	



VALVULA BOLA, T- 21, PVDF / FKM

SOLDADURA TOPE



CÓDIGO	MEDIDA	PRECIO
1628005	½"(20mm)	
1628007	¾"(25mm)	
1628010	1"(32mm)	
1628012	1¼"(40mm)	
1628015	1½"(50mm)	
1628020	2"(63mm)	
1628025	2½"(75mm)	
1628030	3"(90mm)	
1628040	4"(110mm)	



VALVULA BOLA, T- 21, PVDF / FKM

BRIDADA



CÓDIGO	MEDIDA	PRECIO
1629005	½"	
1629007	¾"	
1629010	1"	
1629012	1¼"	
1629015	1½"	
1629020	2"	
1629025	2½"	
1629030	3"	
1629040	4"	
1629060	6"	



VALVULA BOLA DE MUESTREO, PVDF

(CERTIFICADA NSF/ANSI)

CÓDIGO	MEDIDA	PRECIO
1068003	¼"	



VALVULA BOLA TRES VIAS, TRIPLE UNION, T- 23

PVDF / FKM

SOLD. CAJA DIN



CODIGO	MEDIDA	PRECIO
2532005	½"(20mm)	
2532007	¾"(25mm)	
2532010	1"(32mm)	
2532012	1¼"(40mm)	
2532015	1½"(50mm)	
2532020	2"(63mm)	
2532030	3"(90mm)	
2532040	4"(110mm)	



O-RING OPCIONAL, AFLAS

CÓDIGO	MEDIDA	PRECIO
3300005	½"	
3300007	¾"	
3300010	1"	
3300012	1¼"	
3300015	1½"	
3300020	2"	
3300025	2½"	
3300030	3"	
3300040	4"	



VALVULA DE TRES VIAS, TRIPLE UNION, T- 23

PVDF / FKM

SOLDADURA TOPE



CODIGO	MEDIDA	PRECIO
2535005	½"(20mm)	
2535007	¾"(25mm)	
2535010	1"(32mm)	
2535012	1¼"(40mm)	
2535015	1½"(50mm)	
2535020	2"(63mm)	
2535030	3"(90mm)	
2535040	4"(110mm)	



VALVULA BOLA TRES VIAS, TRIPLE UNION, T- 23

PVDF / FKM

ROSCAR



CODIGO	MEDIDA	PRECIO
2534005	½"	
2534007	¾"	
2534010	1"	
2534012	1¼"	
2534015	1½"	
2534020	2"	
2534030	3"	
2534040	4"	





ESFERA PUERTO-T



CODIGO	MEDIDA	PRECIO
3034005	1/2"	
3034007	3/4"	
3034010	1"	
3034015	1 1/4" - 1 1/2"	
3034020	2"	
3034030	3"	
3034040	4" - 6"	

CÓDIGO DESCUENTO

VALVULA DE TRES VIAS, TRIPLE UNION, T- 23
PVDF / FKM



BRIDADA

CODIGO	MEDIDA	PRECIO
2536005	1/2"	
2536007	3/4"	
2536010	1"	
2536012	1 1/4"	
2536015	1 1/2"	
2536020	2"	
2536030	3"	
2536040	4"	
2536060	6"	

CÓDIGO DESCUENTO

ESFERA PUERTO-CRUZ



CODIGO	MEDIDA	PRECIO
3030005	1/2"	
3030007	3/4"	
3030010	1"	
3030012	1 1/4"	
3030015	1 1/2"	
3030020	2"	

CÓDIGO DESCUENTO

ESFERA PUERTO DOBLE L



CODIGO	MEDIDA	PRECIO
3038005	1/2"	
3038007	3/4"	
3038010	1"	
3038015	1 1/4" - 1 1/2"	
3038020	2"	
3038030	2 1/2" - 3"	
3038040	4" - 6"	

CÓDIGO DESCUENTO

ESFERA PUERTO TRIPLE L



CODIGO	MEDIDA	PRECIO
3082005	1/2"	
3082007	3/4"	
3082010	1"	
3082015	1 1/4" - 1 1/2"	
3082020	2"	
3082030	2 1/2" - 3"	
3082040	4" - 6"	

CÓDIGO DESCUENTO

VALVULA MARIPOSA T- 57, PVDF / PVDF / EPDM



OPERADOR PALANCA

CODIGO	MEDIDA	PRECIO
3744015	1 1/2"	
3744020	2"	
3744025	2 1/2"	
3744030	3"	
3744040	4"	
3744050	5"	
3744060	6"	
3744080	8"	

CÓDIGO DESCUENTO

VALVULA MARIPOSA T- 57, PVDF / PVDF / FKM



OPERADOR PALANCA

CODIGO	MEDIDA	PRECIO
3745015	1 1/2"	
3745020	2"	
3745025	2 1/2"	
3745030	3"	
3745040	4"	
3745050	5"	
3745060	6"	
3745080	8"	

CÓDIGO DESCUENTO

VALVULA MARIPOSA T- 57, PVDF / PVDF / EPDM



OPERADOR PLASGEAR

CODIGO	MEDIDA	PRECIO
3728015	1 1/2"	
3728020	2"	
3728025	2 1/2"	
3728030	3"	
3728040	4"	
3728050	5"	
3728060	6"	
3728080	8"	
3728100	10"	
3728120	12"	
3728140	14"	
3728160	16"	

OPERADOR METAL GEAR

CÓDIGO	MEDIDA	PRECIO
3806180	18"	
3806200	20"	
3806240	24"	

CÓDIGO DESCUENTO



VALVULA MARIPOSA T- 57 PVDF / PVDF / EPDM
OPERADOR PALANCA

CÓDIGO
DESCUENTO



VASTAGO SS 304

CODIGO	MEDIDA	PRECIO
3868015	1½"	
3868020	2"	
3868025	2½"	
3868030	3"	
3868040	4"	
3868060	6"	
3868080	8"	

VASTAGO SS 316

CODIGO	MEDIDA	PRECIO
3869015	1½"	
3869020	2"	
3869025	2½"	
3869030	3"	
3869040	4"	
3869060	6"	
3869080	8"	

VALVULA MARIPOSA T- 57, PVDF / PVDF / FKM

CÓDIGO
DESCUENTO



OPERADOR PLASGEAR

CODIGO	MEDIDA	PRECIO
3729015	1½"	
3729020	2"	
3729025	2½"	
3729030	3"	
3729040	4"	
3729050	5"	
3729060	6"	
3729080	8"	
3729100	10"	
3729120	12"	
3729140	14"	
3729160	16"	

OPERADOR METAL GEAR

CODIGO	MEDIDA	PRECIO
3807180	18"	
3807200	20"	
3807240	24"	

VALVULA MARIPOSA T- 57, PVDF / PVDF / FKM
OPERADOR PALANCA

CÓDIGO
DESCUENTO



VASTAGO SS 304

CODIGO	MEDIDA	PRECIO
3870015	1½"	
3870020	2"	
3870025	2½"	
3870030	3"	
3870040	4"	
3870060	6"	
3870080	8"	

VASTAGO SS 316

CODIGO	MEDIDA	PRECIO
3871015	1½"	
3871020	2"	
3871025	2½"	
3871030	3"	
3871040	4"	
3871060	6"	
3871080	8"	

VALVULA MARIPOSA T- 57, PVDF / PVDF / EPDM
OPERADOR PLASGEAR

CÓDIGO
DESCUENTO



VASTAGO SS 304

CODIGO	MEDIDA	PRECIO
3848015	1½"	
3848020	2"	
3848025	2½"	
3848030	3"	
3848040	4"	
3848060	6"	
3848080	8"	
3848100	10"	
3848120	12"	
3848140	14"	
3848160	16"	

VASTAGO SS 316

CODIGO	MEDIDA	PRECIO
3849015	1½"	
3849020	2"	
3849025	2½"	
3849030	3"	
3849040	4"	
3849060	6"	
3849080	8"	
3849100	10"	
3849120	12"	
3849140	14"	
3849160	16"	



VALVULA MARIPOSA T- 57, PVDF / PVDF / FKM
OPERADOR PLASGEAR



VASTAGO SS 304		
CODIGO	MEDIDA	PRECIO
3850015	1½"	
3850020	2"	
3850025	2½"	
3850030	3"	
3850040	4"	
3850060	6"	
3850080	8"	
3850100	10"	
3850120	12"	
3850140	14"	
3850160	16"	



VASTAGO SS 316

CODIGO	MEDIDA	PRECIO
3851015	1½"	
3851020	2"	
3851025	2½"	
3851030	3"	
3851040	4"	
3851060	6"	
3851080	8"	
3851100	10"	
3851120	12"	
3851140	14"	
3851160	16"	

VALVULA MARIPOSA T- 75, PVDF / PVDF / EPDM
OPERADOR METAL GEAR



VASTAGO SS 304		
CODIGO	MEDIDA	PRECIO
3852180	18"	
3852200	20"	
3852240	24"	

VASTAGO SS 316		
CODIGO	MEDIDA	PRECIO
3853180	18"	
3853200	20"	
3853240	24"	



APLICACIONES ESPECIALES, VALVULA T- 55
HIERRO DUCTIL / PTFE / PTFE



OPERADOR DE PALANCA		
CODIGO	MEDIDA	PRECIO
1717020	2"	
1717030	3"	
1717040	4"	
1717050	5"	

OPERADOR PLASGEAR		
CODIGO	MEDIDA	PRECIO
1719020	2"	
1719030	3"	
1719040	4"	
1719050	5"	
1719060	6"	
1719080	8"	
1719100	10"	



VALVULA MARIPOSA, T- 75, PVDF / PVDF / FKM
OPERADOR METAL GEAR



VASTAGO SS 304		
CODIGO	MEDIDA	PRECIO
3854180	18"	
3854200	20"	
3854240	24"	

VASTAGO SS 316		
CODIGO	MEDIDA	PRECIO
3855180	18"	
3855200	20"	
3855240	24"	



VALVULA DIAFRAGMA, T- 14, PVDF / PVDF / TEFLON (ANSI)



SOLD. CAJA DIN		
CODIGO	MEDIDA	PRECIO
1547005	½"(20mm)	
1547007	¾"(25mm)	
1547010	1"(32mm)	
1547012	1¼"(40mm)	
1547015	1½"(50mm)	
1547020	2"(63mm)	

ROSCAR		
CODIGO	MEDIDA	PRECIO
1549005	½"	
1549007	¾"	
1549010	1"	
1549012	1¼"	
1549015	1½"	
1549020	2"	

SOLDADURA TOPE		
CODIGO	MEDIDA	PRECIO
1548005	½"(20mm)	
1548007	¾"(25mm)	
1548010	1"(32mm)	
1548012	1¼"(40mm)	
1548015	1½"(50mm)	
1548020	2"(63mm)	



VALVULA DIAFRAGMA, T- 14, PVDF / PPG / TEFLON (ANSI)

CÓDIGO
DESCUENTO

SOLD. CAJA DIN



CODIGO	MEDIDA	PRECIO
1543005	1/2"(20mm)	
1543007	3/4"(25mm)	
1543010	1"(32mm)	
1543012	1 1/4"(40mm)	
1543015	1 1/2"(50mm)	
1543020	2"(63mm)	

ROSCAR



CODIGO	MEDIDA	PRECIO
1545005	1/2"	
1545007	3/4"	
1545010	1"	
1545012	1 1/4"	
1545015	1 1/2"	
1545020	2"	

SOLDADURA TOPE



CODIGO	MEDIDA	PRECIO
1544005	1/2"(20mm)	
1544007	3/4"(25mm)	
1544010	1"(32mm)	
1544012	1 1/4"(40mm)	
1544015	1 1/2"(50mm)	
1544020	2"(63mm)	

VALVULA DIAFRAGMA, PVDF / PPG / TEFLON - BRIDADA

CÓDIGO
DESCUENTO

T-14



CODIGO	MEDIDA	PRECIO
1468005	1/2"	
1468007	3/4"	
1468010	1"	
1468012	1 1/4"	
1468015	1 1/2"	
1468020	2"	
1468025	2 1/2"	
1468030	3"	
1468040	4"	

T-15



CODIGO	MEDIDA	PRECIO
1468060	6"	

T-G



CODIGO	MEDIDA	PRECIO
1136080	8"	
1136100	10"	

EL DIAFRAGMA DE TEFLON INCLUYE BARRERA DE GAS EN PVDF
DISPONIBLES CON TORNILLOS DE TITANIO, COTIZAR

VALVULA DIAFRAGMA, BRIDADA, PVDF / PPG / TEFLON

CÓDIGO
DESCUENTO

T- TI-14



CODIGO	MEDIDA	PRECIO
1457005	1/2"	
1457007	3/4"	
1457010	1"	
1457012	1 1/4"	
1457015	1 1/2"	
1457020	2"	
1457025	2 1/2"	
1457030	3"	
1457040	4"	

T- TI-15

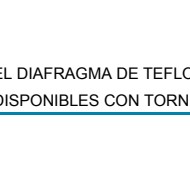

CODIGO	MEDIDA	PRECIO
1457060	6"	

EL DIAFRAGMA DE TEFLON INCLUYE BARRERA DE GAS EN PVDF
DISPONIBLES CON TORNILLOS DE TITANIO, COTIZAR

VALVULA DIAFRAGMA, PVDF / PVDF / TEFLON - BRIDADA

CÓDIGO
DESCUENTO

T-14



CODIGO	MEDIDA	PRECIO
1467005	1/2"	
1467007	3/4"	
1467010	1"	
1467012	1 1/4"	
1467015	1 1/2"	
1467020	2"	
1467025	2 1/2"	
1467030	3"	
1467040	4"	

T-15



CODIGO	MEDIDA	PRECIO
1467060	6"	

T-G



CODIGO	MEDIDA	PRECIO
1135080	8"	
1135100	10"	

EL DIAFRAGMA DE TEFLON INCLUYE BARRERA DE GAS EN PVDF
DISPONIBLES CON TORNILLOS DE TITANIO, COTIZAR

VALVULA DIAFRAGMA C/ACTUADOR NEUMATICO AIRE/AIRE

T-14, PVDF / PPG / EPDM

CÓDIGO
DESCUENTO

SOLD. CAJA DIN



CODIGO	MEDIDA	PRECIO
1892005	1/2"(20mm)	
1892007	3/4"(25mm)	
1892010	1"(32mm)	
1892012	1 1/4"(40mm)	
1892015	1 1/2"(50mm)	
1892020	2"(63mm)	

ROSCAR



CODIGO	MEDIDA	PRECIO
1893005	1/2"	
1893007	3/4"	
1893010	1"	
1893012	1 1/4"	
1893015	1 1/2"	
1893020	2"	

SOLDADURA TOPE



CODIGO	MEDIDA	PRECIO
1894005	1/2"(20mm)	
1894007	3/4"(25mm)	
1894010	1"(32mm)	
1894012	1 1/4"(40mm)	
1894015	1 1/2"(50mm)	
1894020	2"(63mm)	



VALVULA DIAFRAGMA C/ACTUADOR NEUMATICO AIRE/AIRE
T-14, PVDF / PPG / TEFLON



SOLD. CAJA DIN



CODIGO	MEDIDA	PRECIO
1846005	½"(20mm)	
1846007	¾"(25mm)	
1846010	1"(32mm)	
1846012	1¼"(40mm)	
1846015	1½"(50mm)	
1846020	2"(63mm)	

ROSCAR



CODIGO	MEDIDA	PRECIO
1845005	½"	
1845007	¾"	
1845010	1"	
1845012	1¼"	
1845015	1½"	
1845020	2"	

SOLDADURA TOPE



CODIGO	MEDIDA	PRECIO
1864005	½"(20mm)	
1864007	¾"(25mm)	
1864010	1"(32mm)	
1864012	1¼"(40mm)	
1864015	1½"(50mm)	
1864020	2"(63mm)	

VALVULA DIAFRAGMA C/ACTUADOR NEUMATICO AIRE/RESORTE
T-14, PVDF / PPG / TEFLON



SOLD. CAJA DIN



CODIGO	MEDIDA	PRECIO
1834005	½"(20mm)	
1834007	¾"(25mm)	
1834010	1"(32mm)	
1834012	1¼"(40mm)	
1834015	1½"(50mm)	
1834020	2"(63mm)	

ROSCAR



CODIGO	MEDIDA	PRECIO
1833005	½"	
1833007	¾"	
1833010	1"	
1833012	1¼"	
1833015	1½"	
1833020	2"	

SOLDADURA TOPE



CODIGO	MEDIDA	PRECIO
1870005	½"(20mm)	
1870007	¾"(25mm)	
1870010	1"(32mm)	
1870012	1¼"(40mm)	
1870015	1½"(50mm)	
1870020	2"(63mm)	

VALVULA DIAFRAGMA C/ACTUADOR NEUMATICO AIRE/RESORTE
T-14, PVDF / PPG / EPDM



SOLD. CAJA DIN



CODIGO	MEDIDA	PRECIO
1884005	½"(20mm)	
1884007	¾"(25mm)	
1884010	1"(32mm)	
1884012	1¼"(40mm)	
1884015	1½"(50mm)	
1884020	2"(63mm)	

ROSCAR



CODIGO	MEDIDA	PRECIO
1885005	½"	
1885007	¾"	
1885010	1"	
1885012	1¼"	
1885015	1½"	
1885020	2"	

SOLDADURA TOPE



CODIGO	MEDIDA	PRECIO
1886005	½"(20mm)	
1886007	¾"(25mm)	
1886010	1"(32mm)	
1886012	1¼"(40mm)	
1886015	1½"(50mm)	
1886020	2"(63mm)	

VALVULA DIAFRAGMA C/ACTUADOR NEUMATICO AIRE/AIRE
T-14, BRIDA



PVDF / PPG / EPDM



CODIGO	MEDIDA	PRECIO
1421005	½"	
1421007	¾"	
1421010	1"	
1421012	1¼"	
1421015	1½"	
1421020	2"	

PVDF / PPG / TEFLON

CODIGO	MEDIDA	PRECIO
1419005	½"	
1419007	¾"	
1419010	1"	
1419012	1¼"	
1419015	1½"	
1419020	2"	



VALVULA DIAFRAGMA C/ACTUADOR NEUMATICO AIRE/RESORTE T-14, BRIDA



PVDF / PPG / EPDM		
CODIGO	MEDIDA	PRECIO
1422005	1/2"	
1422007	3/4"	
1422010	1"	
1422012	1 1/4"	
1422015	1 1/2"	
1422020	2"	

PVDF / PPG / TEFLON		
CODIGO	MEDIDA	PRECIO
1429005	1/2"	
1429007	3/4"	
1429010	1"	
1429012	1 1/4"	
1429015	1 1/2"	
1429020	2"	

VALVULA CHECK DE BOLA, PVDF/FKM



BRIDADA		
CODIGO	MEDIDA	PRECIO
1233005	1/2"	
1233007	3/4"	
1233010	1"	
1233012	1 1/4"	
1233015	1 1/2"	
1233020	2"	
1233030	3"	
1233040	4"	

VALVULA CHECK COLUMPIO, PVDF / PTFE



BRIDADA		
CODIGO	MEDIDA	PRECIO
1203007	3/4"	
1203010	1"	
1203015	1 1/2"	
1203020	2"	
1203025	2 1/2"	
1203030	3"	
1203040	4"	
1203060	6"	
1203080	8"	

VALVULA CHECK DE BOLA, PVDF / FKM



SOLD. CAJA DIN		
CODIGO	MEDIDA	PRECIO
1290005	1/2"(20mm)	
1290007	3/4"(25mm)	
1290010	1"(32mm)	
1290012	1 1/4"(40mm)	
1290015	1 1/2"(50mm)	
1290020	2"(63mm)	
1290030	3"(90mm)	
1290040	4"(110mm)	

ROSCAR		
CODIGO	MEDIDA	PRECIO
1231005	1/2"	
1231007	3/4"	
1231010	1"	
1231012	1 1/4"	
1231015	1 1/2"	
1231020	2"	
1231030	3"	
1231040	4"	

SOLDADURA TOPE		
CODIGO	MEDIDA	PRECIO
1232005	1/2"(20mm)	
1232007	3/4"(25mm)	
1232010	1"(32mm)	
1232012	1 1/4"(40mm)	
1232015	1 1/2"(50mm)	
1232020	2"(63mm)	
1232030	3"(90mm)	
1232040	4"(110mm)	

VÁLVULAS CHECK T- WAFER SIN RESORTE



PVDF / FPM		
CÓDIGO	MEDIDA	PRECIO
WC5200V	2"	
WC5250V	2 1/2"	
WC5300V	3"	
WC5400V	4"	
WC5600V	6"	
WC5800V	8"	
WC51000V	10"	
WC51200V	12"	
WC51400V	14"	
WC51600V	16"	
WC52000V	20"	

PVDF / TEFLON		
CÓDIGO	MEDIDA	PRECIO
WC5200P	2"	
WC5250P	2 1/2"	
WC5300P	3"	
WC5400P	4"	
WC5600P	6"	
WC5800P	8"	
WC51000P	10"	
WC51200P	12"	
WC51400P	14"	
WC51600P	16"	
WC52000P	20"	



VÁLVULAS CHECK T- WAFER CON RESORTE



PVDF / FPM, RESORTE SS



CÓDIGO	MEDIDA	PRECIO
WC5200VS	2"	
WC5250VS	2½"	
WC5300VS	3"	
WC5400VS	4"	
WC5600VS	6"	
WC5800VS	8"	
WC51000VS	10"	
WC51200VS	12"	
WC51400VS	14"	
WC51600VS	16"	
WC52000VS	20"	

PVDF / TEFLON, RESORTE HASTELLOY

CÓDIGO	MEDIDA	PRECIO
WC5200PH	2"	
WC5250PH	2½"	
WC5300PH	3"	
WC5400PH	4"	
WC5600PH	6"	
WC5800PH	8"	
WC51000PH	10"	
WC51200PH	12"	
WC51400PH	14"	
WC51600PH	16"	
WC52000PH	20"	

ESPACIADOR PARA WAFER CHEK



ESPACIADOR PVDF



CÓDIGO	MEDIDA	PRECIO
WCX502SP	2"	
WCX525SP	2½"	
WCX503SP	3"	
WCX504SP	4"	
WCX506SP	6"	
WCX508SP	8"	
WCX510SP	10"	
WCX512SP	12"	

**VÁLVULA GLOBO DE CONTROL, NEUMÁTICA (A-S)
TEFLON / BRIDADA**



CODIGO	MEDIDA	PRECIO
2503005	½"	
2503007	¾"	
2503010	1"	
2503012	1¼"	
2503015	1½"	
2503020	2"	
2503025	2½"	
2503030	3"	
2503040	4"	

**VÁLVULA GLOBO DE CONTROL, ELECTRICA
TEFLON / BRIDADA, C/POSICIONADOR 4-20 mA**



CODIGO	MEDIDA	PRECIO
2203005	½"	
2203007	¾"	
2203010	1"	
2203012	1¼"	
2203015	1½"	
2203020	2"	
2203025	2½"	
2203030	3"	
2203040	4"	

**VÁLVULA GLOBO DE CONTROL, NEUMÁTICA (A-S)
PVDF / BRIDADA**



CODIGO	MEDIDA	PRECIO
2504005	½"	
2504007	¾"	
2504010	1"	
2504012	1¼"	
2504015	1½"	
2504020	2"	
2504025	2½"	
2504030	3"	
2504040	4"	

**VÁLVULA GLOBO DE CONTROL, ELECTRICA
PVDF / BRIDADA, C/POSICIONADOR 4-20 mA**



CODIGO	MEDIDA	PRECIO
2204005	½"	
2204007	¾"	
2204010	1"	
2204012	1¼"	
2204015	1½"	
2204020	2"	
2204030	3"	
2204040	4"	

SELLO QUIMICO



CÓDIGO	MEDIDA	PRECIO
GG5025X50	¼" x ½"	

POSICIONADORES (ACC)



3-15 PSI PARA NEUMATICA (A-S) ACTUADOR

CÓDIGO	MEDIDA	PRECIO
2455762		



4-20 MA PARA NEUMATICA (A-S) ACTUADOR

CÓDIGO	MEDIDA	PRECIO
2456762		

SELLO QUIMICO C/ MANOMETRO ESTANDAR



PP (0-160 PSI)

CÓDIGO	MEDIDA	PRECIO
GG516050	1/4" x 1/4"	

CÓDIGO
DESCUENTO

SELLO QUÍMICO PVDF/PTFE, C/ MANOMETRO



0-0.6 Bar

CÓDIGO	MEDIDA	PRECIO
17000338A	1/4"x25mm	
17000347A	1/2" x32mm	

0-1.0 Bar

CÓDIGO	MEDIDA	PRECIO
17000338B	1/4"x25mm	
17000347B	1/2" x32mm	

0-1.6 Bar

CÓDIGO	MEDIDA	PRECIO
17000338C	1/4"x25mm	
17000347C	1/2" x32mm	

0-2.5 BAR

CÓDIGO	MEDIDA	PRECIO
17000338D	1/4"x25mm	
17000347D	1/2" x32mm	

0-4 BAR

CÓDIGO	MEDIDA	PRECIO
17000338E	1/4"x25mm	
17000347E	1/2" x32mm	

0-6 BAR

CÓDIGO	MEDIDA	PRECIO
17000338F	1/4"x25mm	
17000347F	1/2" x32mm	

0-10 BAR

CÓDIGO	MEDIDA	PRECIO
17000338G	1/4"x25mm	
17000347G	1/2" x32mm	

CÓDIGO
DESCUENTO

MANOMETRO ESTANDAR



(0-30 PSI)

CÓDIGO	MEDIDA	PRECIO
GG030DUAL	2"	

(0-60 PSI)

CÓDIGO	MEDIDA	PRECIO
GG060DUAL	2"	

(0-160 PSI)

CÓDIGO	MEDIDA	PRECIO
GG160DUAL	2"	

CÓDIGO
DESCUENTO

SELLO QUIMICO C/ MANOMETRO ACERO INOXIDABLE

RELLENO DE GLICERINA



PVDF (0-160 PSI)

CÓDIGO	MEDIDA	PRECIO
GG516050SL	1/4" x 1/4"	

CÓDIGO
DESCUENTO

MANOMETRO CUBIERTO ACERO INOXODABLE

RELLENO DE GLICERINA



(0-160 PSI)

CÓDIGO	MEDIDA	PRECIO
GG160DUALFILL	2"-1/2"	

CÓDIGO
DESCUENTO

SELLO QUÍMICO PVDF/PTFE



CÓDIGO	MEDIDA	PRECIO
17000336	1/4"x25mm	
17000348	1/2" x32mm	

CÓDIGO
DESCUENTO



REGULADOR DE PRESION "BACK PRESSURE"

MOD. V186/86, PVDF/PTFE/FKM

SOLDADURA TOPE	CÓDIGO		PRECIO
	CODIGO	MEDIDA	
	590244005	½"(20mm)	
	590244007	¾"(25mm)	
	590244010	1"(32mm)	
	590244012	1¼"(40mm)	
	590244015	1½"(50mm)	
	590244020	2"(63mm)	
	590244025	2½"(75mm)	

REGULADOR DE PRESION C/MANOMETRO

MOD. V182/82, PVDF/PTFE/FKM

SOLDADURA TOPE	CÓDIGO		PRECIO
	CODIGO	MEDIDA	
	590241005	½"(20mm)	
	590241007	¾"(25mm)	
	590241010	1"(32mm)	
	590241012	1¼"(40mm)	
	590241015	1½"(50mm)	
	590241020	2"(63mm)	
	590241025	2½"(75mm)	

REGULADOR DE PRESION, HIGH PERFORMANCE

MOD. V782, PVDF/PTFE/FKM

SOLDADURA TOPE	CÓDIGO		PRECIO
	CODIGO	MEDIDA	
	590243005	½"(20mm)	
	590243007	¾"(25mm)	
	590243010	1"(32mm)	
	590243012	1¼"(40mm)	
	590243015	1½"(50mm)	

REGULADOR DE PRESION HIGH PERFORMANCE "BACK PRESSURE"

MOD. V786, PVDF/PTFE/FKM

SOLDADURA TOPE	CÓDIGO		PRECIO
	CODIGO	MEDIDA	
	590249005	½"(20mm)	
	590249007	¾"(25mm)	
	590249010	1"(32mm)	
	590249012	1¼"(40mm)	
	590249015	1½"(50mm)	

VALVULA DE ALIVIO DE PRESION

MOD. V185/85, PVDF/PTFE/FKM

SOLDADURA TOPE	CÓDIGO		PRECIO
	CODIGO	MEDIDA	
	590245005	½"(20mm)	
	590245007	¾"(25mm)	
	590245010	1"(32mm)	
	590245012	1¼"(40mm)	
	590245015	1½"(50mm)	
	590245020	2"(63mm)	
	590245025	2½"(75mm)	



FILTROS BOLSA SIMPLEX, PVDF/VITON - BRIDADO



LARGO DOBLE (7" X 32", 2 BOLSAS)

CÓDIGO	MEDIDA	PRECIO
FLT5202F	2"	

MANÓMETRO DE PRESIÓN DIFERENCIAL



ALUMINIO / NYLON

CÓDIGO	MEDIDA	PRECIO
FLTDPAL		

SS / PTFE

CÓDIGO	MEDIDA	PRECIO
FLTDPS		

FILTROS BOLSA PP MONOFILAMENTO - COSIDO



LARGO SIMPLE 16", CAJA DE 50

CÓDIGO	MEDIDA	PRECIO
F3AB00170	150 MICRÓN	
F3AB00173	400 MICRÓN	
F3AB00174	600 MICRÓN	
F3AB00175	800 MICRÓN	

LARGO DOBLE 32", CAJA DE 50

CÓDIGO	MEDIDA	PRECIO
F3AB00177	150 MICRÓN	
F3AB00180	400 MICRÓN	
F3AB00181	600 MICRÓN	
F3AB00182	800 MICRÓN	

SWITCH DIFERENCIAL DE PRESIÓN



CÓDIGO	MEDIDA	PRECIO
FLTDPSW		

FILTRO BOLSA PP - ARO COSIDO



LARGO SIMPLE 16", CAJA DE 50

CÓDIGO	MEDIDA	PRECIO
F3AB00013	1 MICRÓN	
F3AB00157	5 MICRÓN	
F3AB00019	10 MICRÓN	
F3AB00020	25 MICRÓN	
F3AB00014	50 MICRÓN	
F31A37288	100 MICRÓN	
F3AB00103	200 MICRÓN	

LARGO DOBLE 32", CAJA DE *

CÓDIGO	MEDIDA	PRECIO	* CAJA
F31B36372	1 MICRÓN		30
F31B37455	5 MICRÓN		50
F3AA01434	10 MICRÓN		50
F3AB00002	25 MICRÓN		50
F3AA00160	50 MICRÓN		50
F3AA01128	100 MICRÓN		50
F3AB00057	200 MICRÓN		30

FILTRO BOLSA PP - FUNDIDO

ARO PLÁSTICO SENTINEL



LARGO SIMPLE 16", CAJA DE 50

CÓDIGO	MEDIDA	PRECIO
F31R36590	1 MICRÓN	
F31R36817	5 MICRÓN	
F31R36552	10 MICRÓN	
F31R36596	25 MICRÓN	
F31R36589	50 MICRÓN	
F31R36551	100 MICRÓN	
F3AB00319	200 MICRÓN	

LARGO DOBLE 32", CAJA DE 30

CÓDIGO	MEDIDA	PRECIO
F31S36502	1 MICRÓN	
F31S36501	5 MICRÓN	
F31S36503	10 MICRÓN	
F31S36412	25 MICRÓN	
F31S36500	50 MICRÓN	
F31S36505	100 MICRÓN	
F3AB00222	200 MICRÓN	

EQUIPOS TERMOFUSION



VENTA

SHOP 4 MINIPLAST PARA FUSION A TOPE DE 110V



CODIGO	MEDIDA	PRECIO
5730000	20-110MM	

SHOP 12 W25000 PARA FUSION A TOPE DE 110V



CODIGO	MEDIDA	PRECIO
5722000	50-315 MM	

RENTA

SHOP 4 MINIPLAST PARA FUSION A TOPE DE 110V



CODIGO	MEDIDA	PRECIO
9730000-2	SEMANAL	
9730000-3	MENSUAL	

SHOP 12 W25000 PARA FUSION A TOPE DE 110V



CODIGO	MEDIDA	PRECIO
9722000-2	SEMANAL	
9722000-3	MENSUAL	

PARA RENTA SE DEBE FIRMAR CONTRATO

RENTA DIARIA, COTIZAR POR EVENTO

ACCESORIOS



CORTADOR MANUAL DE TUBERÍA



CODIGO	MEDIDA	PRECIO
790109001	16-63MM	
790109002	50-110MM	
790109003	110-160MM	

RUEDA DE REPUESTO



CODIGO	MEDIDA	PRECIO
790109011	16-63MM	
790109012	50-110MM	
790109013	110-160MM	

PE-100 (Polietileno)

Pág. **PE-100 (Polietileno)**

69 ▶ Tubería de PE-100

73 ▶ Conexión de PE-100 Soldadura a Tope (Butt)

 * RD-11 (Extremos Largos, Extremos Cortos y Accesorios)

 * RD-17 / 17.6 (Extremos Largos, Extremos Cortos y Accesorios)

 * RD-33 (Extremos Largos, Extremos Cortos y Accesorios)

 * Accesorios (Bridas, Empaques y Soportes de Tubería)

102 ▶ Equipos de Termofusión

CORRELACION SDR Y PRESION NOMINAL (PN) PARA PE-100

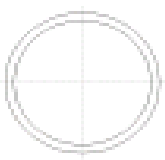

DIAM. (mm)	DIAM. APROX PULG.
16	3/8
20	1/2
25	3/4
32	1
40	1 1/4
50	1 1/2
63	2
75	2 1/2
90	3
110	4
160	6
200	8
225	9
250	10
315	12
355	14
400	16

SDR	PN (BAR)	PSI
7.4	25	362.59
11	16	232.06
17	10	145.03
17,6	9.7	140.68
26	6.3	91.37
33	5	72.51
41	4	58.01

NOTAS:
 1.- FACTOR DE SEGURIDAD 1.25
 2.- VALORES REMETIDOS A 20°C Y VIDA UTIL DE 50 ANOS, PARA CONEXIÓN INYECTADA.

TUBERIA PE-100 RD 11



LONGITUD ESTANDAR 6 m

CÓDIGO	MEDIDA	PRECIO
010002865	10 mm	
010002866	12 mm	
010002867	16 mm	
010001100	20 mm	
010001101	25 mm	
010001616	32 mm	
010001103	40 mm	
010001104	50 mm	
010001105	63 mm	
010001619	75 mm	
010001107	90 mm	
010001108	110 mm	
010000610	125 mm	
010001620	140 mm	
010000611	160 mm	
010000612	180 mm	
010001110	200 mm	
010001111	225 mm	
010001623	250 mm	
010001624	280 mm	
010001627	315 mm	
010001628	355 mm	
010001631	400 mm	
010001632	450 mm	
010001635	500 mm	
010001636	560 mm	
010001639	630 mm	

**CÓDIGO
DESCUENTO**

TUBERIA PE-100 RD 7.4



LONGITUD ESTANDAR 6 m

CÓDIGO	MEDIDA	PRECIO
010002837	50 mm	
010002838	63 mm	
010002839	75 mm	
010002840	90 mm	
010002841	110 mm	
010002842	125 mm	
010002843	140 mm	
010002844	160 mm	
010002845	180 mm	
010002846	200 mm	
010002847	225 mm	
010002848	250 mm	
010002849	280 mm	
010002850	315 mm	
010002851	355 mm	
010002852	400 mm	
010002853	450 mm	

**CÓDIGO
DESCUENTO**

TUBERÍA PE-100 RD 26



LONGITUD ESTANDAR 6 m



CÓDIGO	MEDIDA	PRECIO
010002812	40 mm	
010002813	50 mm	
010002814	63 mm	
010002815	75 mm	
010002816	90 mm	
010002817	110 mm	
010002818	125 mm	
010002819	140 mm	
010002820	160 mm	
010002821	180 mm	
010002822	200 mm	
010002823	225 mm	
010002824	250 mm	
010002825	280 mm	
010002826	315 mm	
010002827	355 mm	
010002828	400 mm	
010002829	450 mm	
010002830	500 mm	
010002831	560 mm	
010002832	630 mm	
010002833	710 mm	
010002834	800 mm	
010002835	900 mm	
010002836	1000 mm	

TUBERÍA PE-100 RD 17



LONGITUD ESTANDAR 6 m



CÓDIGO	MEDIDA	PRECIO
010002949	32 mm	
010001077	40 mm	
010001078	50 mm	
010001079	63 mm	
010001080	75 mm	
010001081	90 mm	
010001082	110 mm	
010001083	125 mm	
010001084	140 mm	
010001085	160 mm	
010001086	180 mm	
010001087	200 mm	
010001088	225 mm	
010001089	250 mm	
010001090	280 mm	
010000613	315 mm	
010001091	355 mm	
010001092	400 mm	
010000614	450 mm	
010001093	500 mm	
010001094	560 mm	
010001095	630 mm	
010001096	710 mm	
010001097	800 mm	
010001098	900 mm	
010001099	1000 mm	

TUBERÍA PE-100 RD 41



LONGITUD ESTANDAR 6 m



CÓDIGO	MEDIDA	PRECIO
010002767	75 mm	
010002768	90 mm	
010002769	110 mm	
010002770	125 mm	
010002771	140 mm	
010002772	160 mm	
010002773	180 mm	
010002774	200 mm	
010002775	225 mm	
010002776	250 mm	
010002777	280 mm	
010002778	315 mm	
010002779	355 mm	
010002780	400 mm	
010002781	450 mm	
010002782	500 mm	
010002783	560 mm	
010002784	630 mm	
010002785	710 mm	
010002786	800 mm	
010002787	900 mm	
010002788	1000 mm	

TUBERÍA PE-100 RD 33



LONGITUD ESTANDAR 6 m



CÓDIGO	MEDIDA	PRECIO
010002789	63 mm	
010002790	75 mm	
010002791	90 mm	
010002792	110 mm	
010002793	125 mm	
010002794	140 mm	
010002795	160 mm	
010002796	180 mm	
010002797	200 mm	
010002798	225 mm	
010002799	250 mm	
010002800	280 mm	
010002801	315 mm	
010002802	355 mm	
010002803	400 mm	
010002804	450 mm	
010002805	500 mm	
010002806	560 mm	
010002807	630 mm	
010002808	710 mm	
010002809	800 mm	
010002810	900 mm	
010002811	1000 mm	

ROLLO DE TUBERIA PE-100 RD 11



AGUA POTABLE

CÓDIGO	MEDIDA	PRECIO
010003137	20 mm	
010003138	25 mm	
010003139	32 mm	
010003140	40 mm	
010003141	50 mm	
010003142	63 mm	
010003143	75 mm	
010003144	90 mm	
010003145	110 mm	
010003146	125 mm	
010003147	160 mm	
010003148	180 mm	

AGUAS RESIDUALES

CÓDIGO	MEDIDA	PRECIO
010001666	20 mm	
010001667	25 mm	
010001668	32 mm	
010001669	40 mm	
010001670	50 mm	
010001671	63 mm	
010001672	75 mm	
010001673	90 mm	
010001674	110 mm	
010001675	125 mm	
010001677	160 mm	
010001678	180 mm	

TUBERIA PE-100 PARA AGUA POTABLE RD 11 REVESTIMIENTO PP AZUL



LONGITUD ESTANDAR 12m

CÓDIGO	MEDIDA	PRECIO
010002602	90 mm	
010002603	110 mm	
010002604	125 mm	
010002605	140 mm	
010002606	160 mm	
010002607	180 mm	
010002608	200 mm	
010002609	225 mm	
010002610	250 mm	
010002611	280 mm	
010002612	315 mm	
010002613	355 mm	
010002614	400 mm	
010002615	450 mm	
010002616	500 mm	
010002617	560 mm	
010002618	630 mm	

ROLLO DE TUBERIA PE-100 RD 17



AGUA POTABLE

CÓDIGO	MEDIDA	PRECIO
010003149	32 mm	
010003150	40 mm	
010003151	50 mm	
010003152	63 mm	
010003153	75 mm	
010003154	90 mm	
010003155	110 mm	



AGUAS RESIDUALES

CÓDIGO	MEDIDA	PRECIO
010002870	32 mm	
010001680	40 mm	
010001681	50 mm	
010001682	63 mm	
010001683	75 mm	
010001684	90 mm	
010001685	75 mm	

TUBERIA PE-100 PARA AGUA POTABLE RD 17 REVESTIMIENTO PP AZUL



LONGITUD ESTANDAR 12m

CÓDIGO	MEDIDA	PRECIO
010002585	90 mm	
010002586	110 mm	
010002587	125 mm	
010002588	140 mm	
010002589	160 mm	
010002590	180 mm	
010002591	200 mm	
010002592	225 mm	
010002593	250 mm	
010002594	280 mm	
010002595	315 mm	
010002596	355 mm	
010002597	400 mm	
010002598	450 mm	
010002599	500 mm	
010002600	560 mm	
010002601	630 mm	

SIMODRAIN



SDR 11

CÓDIGO	MEDIDA	PRECIO
	160 mm	
	180 mm	
	200 mm	
	225 mm	
	250 mm	
	280 mm	
	315 mm	
	355 mm	
	400 mm	
	450 mm	

SDR 17

CODIGO	MEDIDA	PRECIO
	160 mm	
	200 mm	
	250 mm	
	315 mm	
	355 mm	
	400 mm	

SIMODRAIN



SDR 17.6

CODIGO	MEDIDA	PRECIO
	160 mm	
	200 mm	
	250 mm	
	315 mm	
	355 mm	
	400 mm	

SDR 22

CODIGO	MEDIDA	PRECIO
	160 mm	
	200 mm	
	250 mm	
	315 mm	
	355 mm	
	400 mm	

COPLE ELECTROSOLDABLE PE-100, RD 11



CODIGO	MEDIDA	PRECIO
014300103	20 mm	
014300104	25 mm	
014300105	32 mm	
014300106	40 mm	
014300107	50 mm	
014300108	63 mm	
014300109	75 mm	
014300110	90 mm	
014300111	110 mm	
014300112	125 mm	
014300113	140 mm	
014300114	160 mm	
014300115	180 mm	
014300116	200 mm	
014300117	225 mm	
014300118	250 mm	
014300119	315 mm	
014300099	280 mm	
014300101	355 mm	
014300102	400 mm	
014300129	450 mm	
014300130	500 mm	
014300131	560 mm	
014300132	630 mm	
014300133	710 mm	

CÓDIGO
DESCUENTO

SILLETA SOLDABLE PE-100, RD 11



CODIGO	MEDIDA	PRECIO
024100035	225 mm	
024100036	250 mm	
024100037	280 mm	
024100039	355 mm	
024100040	400 mm	
010006407	450 mm	
010006408	500 mm	
010006409	560 mm	

CÓDIGO
DESCUENTO

ABRAZADERA PE-100, RD 11

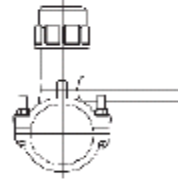

CODIGO	MEDIDA	PRECIO
015700042	40/20 mm	
015700043	40/32 mm	
015700044	50/20 mm	
015700045	50/32 mm	
015700046	63/20 mm	
015700047	63/32 mm	
015700048	63/40 mm	
015700049	63/50 mm	
015700050	63/63 mm	
015700051	75/32 mm	
015700052	75/40 mm	
015700053	75/50 mm	
015700054	75/63 mm	
015700055	90/32 mm	
015700056	90/40 mm	
015700057	90/50 mm	
015700058	90/63 mm	
015700059	110/32 mm	
015700060	110/40 mm	
015700061	110/50 mm	
015700062	110/63 mm	
015700063	125/32 mm	
015700064	125/40 mm	
015700065	125/50 mm	
015700066	125/63 mm	
015700067	140/32 mm	
015700068	140/40 mm	
015700069	140/50 mm	
015700070	140/63 mm	
015700071	160/32 mm	
015700072	160/40 mm	
015700073	160/50 mm	
015700074	160/63 mm	
015700075	180/32 mm	
015700076	180/40 mm	
015700077	180/50 mm	
015700078	180/63 mm	
015700079	200/32 mm	
015700080	200/40 mm	
015700081	200/50 mm	
015700082	200/63 mm	
015700083	225/32 mm	
015700084	225/40 mm	
015700085	225/50 mm	
015700086	225/63 mm	
015700087	250/32 mm	
015700088	250/40 mm	
015700089	250/50 mm	
015700090	250/63 mm	

CÓDIGO
DESCUENTO

CODO 90° PE-100, EXT LARGOS, RD 11



CÓDIGO	MEDIDA	PRECIO
019200177	20 mm	
019200178	25 mm	
019200179	32 mm	
019200180	40 mm	
019200181	50 mm	
019200182	63 mm	
019200071	75 mm	
019200183	90 mm	
019200184	110 mm	
019200072	125 mm	
019200257	140 mm	
019200073	160 mm	
019200185	180 mm	
019200186	200 mm	
019200187	225 mm	
019200285	250 mm	
019200287	280 mm	
019200289	315 mm	

CÓDIGO
DESCUENTO

CODO 90° RADIO LARGO PE-100, EXT LARGOS, RD 11



CÓDIGO	MEDIDA	PRECIO
019100128	20 mm	
019100129	25 mm	
019100130	32 mm	
019100131	40 mm	
019100133	50 mm	
019100032	63 mm	
019100044	75 mm	
019100046	90 mm	
019100048	110 mm	
019100051	125 mm	
019100052	140 mm	
019100053	160 mm	
019100054	180 mm	
019100055	200 mm	
019100050	225 mm	
019100092	250 mm	
019100094	280 mm	
019100096	315 mm	

CODO 90° SIN COSTURA PE-100, EXT LARGOS RD 11



CÓDIGO	MEDIDA	PRECIO
010101927	32 mm	
010101928	40 mm	
010101931	50 mm	
010101934	63 mm	
010101937	75 mm	
010101940	90 mm	
010101943	110 mm	
010101946	125 mm	
010101949	140 mm	
010101952	160 mm	
010101955	180 mm	
010101958	200 mm	
010101961	225 mm	
010101964	250 mm	
010101967	280 mm	
010101970	315 mm	
010102656	355 mm	
010102658	400 mm	
010102660	450 mm	
010102662	500 mm	
010102664	560 mm	
010102666	630 mm	

CODO 90° PE-100 FABRICADO, EXT LARGOS, RD 11



CÓDIGO	MEDIDA	PRECIO
010101846	90 mm	
010101849	110 mm	
010101852	125 mm	
010101855	140 mm	
010101858	160 mm	
010101861	180 mm	
010101864	200 mm	
010101867	225 mm	
010101870	250 mm	
010101873	280 mm	
010101876	315 mm	
010101879	355 mm	
010101882	400 mm	
010101885	450 mm	
010101888	500 mm	
010101891	560 mm	
010101894	630 mm	

CODO 45° PE-100, EXT LARGOS, RD 11



CÓDIGO	MEDIDA	PRECIO
019200207	20 mm	
019200208	25 mm	
019200209	32 mm	
019200210	40 mm	
019200211	50 mm	
019200212	63 mm	
019200213	75 mm	
019200214	90 mm	
019200215	110 mm	
019200216	125 mm	
019200338	140 mm	
019200217	160 mm	
019200218	180 mm	
019200219	200 mm	
019200220	225 mm	
019200279	250 mm	
019200281	280 mm	
019200283	315 mm	

CODO 45° SIN COSTURA PE-100, EXT LARGOS, RD 11



CODIGO	MEDIDA	PRECIO
010101615	32 mm	
010101616	40 mm	
010101619	50 mm	
010101622	63 mm	
010101625	75 mm	
010101628	90 mm	
010101631	110 mm	
010101634	125 mm	
010101637	140 mm	
010101640	160 mm	
010101643	180 mm	
010101646	200 mm	
010101648	225 mm	
010101651	250 mm	
010101653	280 mm	
010101656	315 mm	
010102063	355 mm	
010102681	400 mm	
010102683	450 mm	
010102685	500 mm	
010102687	560 mm	
010102689	630 mm	

CODO 45° PE-100 FABRICADO, EXT LARGOS RD 11



CÓDIGO	MEDIDA	PRECIO
010101561	110 mm	
010101564	125 mm	
010101567	140 mm	
010101570	160 mm	
010101573	180 mm	
010101576	200 mm	
010101579	225 mm	
010101582	250 mm	
010101585	280 mm	
010101588	315 mm	
010101591	355 mm	
010101594	400 mm	
010101597	450 mm	
010101600	500 mm	
010101603	560 mm	
010101606	630 mm	

CODO 60° PE-100 FABRICADO, EXT LARGOS, RD 11



CÓDIGO	MEDIDA	PRECIO
010101701	90 mm	
010101704	110 mm	
010101707	125 mm	
010101710	140 mm	
010101713	160 mm	
010101716	180 mm	
010101719	200 mm	
010101722	225 mm	
010101725	250 mm	
010101728	280 mm	
010101731	315 mm	
010101734	355 mm	
010101737	400 mm	
010101740	450 mm	
010101743	500 mm	
010101746	560 mm	
010101749	630 mm	

CODO 60° SIN COSTURA PE-100, EXT LARGOS, RD 11



CÓDIGO	MEDIDA	PRECIO
010101758	32 mm	
010101759	40 mm	
010101762	50 mm	
010101765	63 mm	
010101768	75 mm	
010101771	90 mm	
010101774	110 mm	
010101777	125 mm	
010101780	140 mm	
010101783	160 mm	
010101786	180 mm	
010101789	200 mm	
010101792	225 mm	
010101795	250 mm	
010101798	280 mm	
010101801	315 mm	
010102668	355 mm	
010102670	400 mm	
010102672	450 mm	
010102674	500 mm	
010102676	560 mm	
010102678	630 mm	

CODO 22° SIN COSTURA PE-100, EXT LARGOS, RD 11



CODIGO	MEDIDA	PRECIO
010102702	32 mm	
010102703	40 mm	
010102705	50 mm	
010102707	63 mm	
010102709	75 mm	
010102377	90 mm	
010102379	110 mm	
010102381	125 mm	
010102710	140 mm	
010102384	160 mm	
010102386	180 mm	
010102712	200 mm	
010102388	225 mm	
010102389	250 mm	
010102714	280 mm	
010102392	315 mm	
010102717	355 mm	
010102719	400 mm	
010102721	450 mm	
010102723	500 mm	
010102725	560 mm	
010102727	630 mm	

CODO 30° SIN COSTURA PE-100, EXT LARGOS, RD 11



CÓDIGO	MEDIDA	PRECIO
010101471	32 mm	
010101472	40 mm	
010101475	50 mm	
010101478	63 mm	
010101481	75 mm	
010101484	90 mm	
010101487	110 mm	
010101490	125 mm	
010101493	140 mm	
010101496	160 mm	
010101499	180 mm	
010101502	200 mm	
010101505	225 mm	
010101508	250 mm	
010101510	280 mm	
010101513	315 mm	
010102691	355 mm	
010102693	400 mm	
010102695	450 mm	
010102697	500 mm	
010102699	560 mm	
010102701	630 mm	

CODO 11° SIN COSTURA PE-100, EXT LARGOS RD 11



CODIGO	MEDIDA	PRECIO
010102728	32 mm	
010102729	40 mm	
010102731	50 mm	
010102733	63 mm	
010102735	75 mm	
010102361	90 mm	
010102363	110 mm	
010102365	125 mm	
010102736	140 mm	
010102368	160 mm	
010102370	180 mm	
010102738	200 mm	
010102372	225 mm	
010102740	250 mm	
010102741	280 mm	
010102743	315 mm	
010102745	355 mm	
010102747	400 mm	
010102749	450 mm	
010102751	500 mm	
010102753	560 mm	
010102755	630 mm	

CODO 30° PE-100 FABRICADO, EXT LARGOS, RD 11



CÓDIGO	MEDIDA	PRECIO
010101416	90 mm	
010101419	110 mm	
010101422	125 mm	
010101425	140 mm	
010101428	160 mm	
010101431	180 mm	
010101434	200 mm	
010101437	225 mm	
010101440	250 mm	
010101443	280 mm	
010101446	315 mm	
010101449	355 mm	
010101451	400 mm	
010101453	450 mm	
010101456	500 mm	
010101459	560 mm	
010101462	630 mm	

**STUB END PE-100 (PORTABRIDA) ISO/DIN, RD 11
EXTREMOS LARGOS**



CÓDIGO	MEDIDA	PRECIO
019400116	20 mm	
019400117	25 mm	
019400105	32 mm	
019400106	40 mm	
019400108	50 mm	
019400034	63 mm	
019400035	75 mm	
019400037	90 mm	
019400039	110 mm	
019400041	125 mm	
019400111	140 mm	
019400043	160 mm	
019400046	180 mm	
019400112	200 mm	
019400050	225 mm	
019400129	250 mm	
019400132	280 mm	
019400134	315 mm	
019400192	355 mm	
019400194	400 mm	

**STUB END PE-100 (PORTABRIDA) ISO/DIN, RD 11
FABRICADA, EXT LARGOS**



CÓDIGO	MEDIDA	PRECIO
010006411	450 mm	
010006412	500 mm	
010006413	560 mm	
010006414	630 mm	

TEE FABRICADA PE-100, EXT LARGOS, RD 11



CODIGO	MEDIDA	PRECIO
010300658	90 mm	
010300661	110 mm	
010300664	125 mm	
010300667	140 mm	
010300670	160 mm	
010300673	180 mm	
010300676	200 mm	
010300679	225 mm	
010300682	250 mm	
010300685	280 mm	
010300688	315 mm	
010300691	355 mm	
010300694	400 mm	
010300697	450 mm	
010300700	500 mm	
010300703	560 mm	
010300706	630 mm	

TEE PE-100, EXT LARGOS, RD 11



CÓDIGO	MEDIDA	PRECIO
010300713	20 mm	
010300714	25 mm	
010300592	32 mm	
010300593	40 mm	
010300595	50 mm	
010300597	63 mm	
010300128	75 mm	
010300600	90 mm	
010300602	110 mm	
010300129	125 mm	
010300605	140 mm	
010300130	160 mm	
010300131	180 mm	
010300609	200 mm	
010300133	225 mm	
010300135	250 mm	
010300611	280 mm	
010300613	315 mm	
019300087	355mm	
019300089	400mm	
019300206	450mm	
019300208	500mm	

TEE FABRICADA/REFORZADA PE-100, EXT LARGOS, RD 11



CÓDIGO	MEDIDA	PRECIO
010006428	560 mm	
010006429	630 mm	

TEE REDUCIDA PE-100, EXT LARGOS, RD 11



CODIGO	MEDIDA	PRECIO
013500846	63/50 mm	
013500847	75/63 mm	
013500848	75/50 mm	
013500849	75/63 mm	
013500692	90/50 mm	
013500693	90/63 mm	
013500850	90/75 mm	
013500694	110/63 mm	
013500695	110/90 mm	
013500851	110/75 mm	
013500852	125/110 mm	
013500696	160/90 mm	
013500697	160/110 mm	
013500853	160/63 mm	
013500854	160/75 mm	
013500855	180/160 mm	
022300053	200/63 mm	
022300054	200/90 mm	
022300055	200/110 mm	
022300056	200/160 mm	
013500698	225/90 mm	
013500699	250/110 mm	
013500700	250/160 mm	
013500856	225/75 mm	
013500857	225/180 mm	
022300124	225/110 mm	
022300125	225/160 mm	
022300100	315/110 mm	
022300101	315/160 mm	
022300082	315/250 mm	

TAPON PE-100, EXT LARGOS, RD 11



CODIGO	MEDIDA	PRECIO
013900314	20 mm	
013900315	25 mm	
013900316	32 mm	
013900317	40 mm	
013900320	50 mm	
013900323	63 mm	
013900326	75 mm	
013900329	90 mm	
013900332	110 mm	
013900335	125 mm	
013900338	140 mm	
013900341	160 mm	
013900344	180 mm	
013900347	200 mm	
013900350	225 mm	
019600003	250 mm	
019600056	280 mm	
019600062	315 mm	
019600058	355mm	
019600060	400mm	

TEE REDUCIDA FABRICADA PE-100, EXT LARGOS, RD 11



CODIGO	MEDIDA	PRECIO
010010494	90/40 mm	
013500858	90/50 mm	
010010495	110/40 mm	
013500860	110/50 mm	
013500861	110/63 mm	
013500863	125/50 mm	
013500864	125/63 mm	
013500865	125/75 mm	
013500867	140/63 mm	
013500868	140/75 mm	
013500869	140/90 mm	
013500871	160/63 mm	
013500872	160/75 mm	
010010496	125/40 mm	
013500873	160/90 mm	
013500874	160/110 mm	
013500875	180/75 mm	
013500876	180/90 mm	
013500877	180/110 mm	
013500879	200/75 mm	
013500880	200/90 mm	
013500881	200/110 mm	
013500882	200/140 mm	
013500884	225/75 mm	
013500885	225/90 mm	
013500886	225/110 mm	
013500887	225/140 mm	
013500888	225/160 mm	
013500890	250/90 mm	
013500891	250/110 mm	
013500892	250/140 mm	
013500893	250/160 mm	
013500894	250/180 mm	
013500896	280/90 mm	
013500897	280/110 mm	
013500899	280/160 mm	
013500900	280/180 mm	
013500903	315/110 mm	
013500906	315/180 mm	
013500910	355/110 mm	
013500911	355/140 mm	
013500926	450/140 mm	
013500918	400/140 mm	
013500919	400/160 mm	
013500898	280/140 mm	
013500904	315/140 mm	
013500934	500/160 mm	
013500905	315/160 mm	
013500912	355/160 mm	
013500927	450/160 mm	
013500928	450/180 mm	
013500920	400/180 mm	
013500935	500/180 mm	
013500913	355/180 mm	
013500942	560/180 mm	
013500914	355/200 mm	
013500943	560/200 mm	
013500929	450/200 mm	
013500921	400/200 mm	
013500936	500/200 mm	

TEE REDUCIDA FABRICADA PE-100, EXT LARGOS, RD 11



CODIGO	MEDIDA	PRECIO
013500901	280/200 mm	
013500907	315/200 mm	
013500937	500/250 mm	
013500908	315/225 mm	
013500944	560/225 mm	
013500915	355/225 mm	
013500930	450/225 mm	
013500922	400/225 mm	
013500923	400/250 mm	
013500938	500/250 mm	
013500945	560/250 mm	
013500931	450/250 mm	
013500916	355/250 mm	
013500946	560/280 mm	
013500932	450/280 mm	
013500924	400/280 mm	
013500939	500/280 mm	
013500940	500/315 mm	
013500947	560/315 mm	
013500933	450/315 mm	
013500941	500/355 mm	
013500948	560/355 mm	
013500949	560/400 mm	
010010497	140/40 mm	
010010498	140/50 mm	
010010499	160/50 mm	
010010577	160/125 mm	
010010500	180/50 mm	
010010501	180/63 mm	
010010578	180/125 mm	
010010502	200/63 mm	
010010579	200/125 mm	
010010503	225/63 mm	
010010504	225/125 mm	
010010505	250/63 mm	
010010506	250/75 mm	
010010507	250/125 mm	
010010580	280/125 mm	
010010508	315/90 mm	
010010509	315/125 mm	
010010510	355/90 mm	
010010511	355/125 mm	
010010512	400/90 mm	
010010513	400/110 mm	
013501035	400/125 mm	
010010514	450/110 mm	
010010515	450/125 mm	
010010516	500/110 mm	
010010517	500/125 mm	
010010518	500/140 mm	
010010519	560/160 mm	
010010520	630/160 mm	
010010521	630/180 mm	
010010522	630/200 mm	
010010523	630/225 mm	
010010524	630/250 mm	
010010525	630/280 mm	
010010526	630/315 mm	
010010527	630/355 mm	
010010528	630/400 mm	

TAPON FABRICADO PE-100, EXT LARGOS, RD 11



CODIGO	MEDIDA	PRECIO
010006420	450 mm	
010006421	500 mm	
010006422	560 mm	
010006423	630 mm	

ADAP HEMBRA ROSCADO PE-100, EXT LARGOS, RD 11



CODIGO	MEDIDA	PRECIO
019900013	20 X 1/2"	
019900014	25 X 3/4"	
019900015	32 X 1"	
019900016	40 X 1 1/4"	
019900017	50 X 1 1/2"	
019900018	63 X 2"	

ADAP MACHO ROSCADO PE-100, EXT LARGOS, RD 11



CODIGO	MEDIDA	PRECIO
020000013	20 X 1/2"	
020000014	25 X 3/4"	
020000015	32 X 1"	
020000016	40 X 1 1/4"	
020000017	50 X 1 1/2"	
020000018	63 X 2"	

UNION PE/FPM, SDR 11



CODIGO	MEDIDA	PRECIO
	20 mm	
	25 mm	
	32 mm	
	40 mm	
	50 mm	
	63 mm	

UNION PE/EPDM, SDR 11



CODIGO	MEDIDA	PRECIO
	20 mm	
	25 mm	
	32 mm	
	40 mm	
	50 mm	
	63 mm	

YEE 60° FABRICADA PE-100, EXT LARGOS, RD 11



CODIGO	MEDIDA	PRECIO
013700576	110mm	
013700579	125mm	
013700582	140mm	
013700585	160mm	
013700588	180mm	
013700591	200 mm	
013700594	225 mm	
013700597	250 mm	
013700600	280 mm	
013700603	315 mm	
013700606	355mm	
013700609	400mm	
013700612	450mm	
013700615	500mm	
013700618	560 mm	
013700621	630 mm	

YEE 45° FABRICADA PE-100, EXT LARGOS, RD 11



CODIGO	MEDIDA	PRECIO
013700528	110mm	
013700531	125mm	
013700534	140mm	
013700537	160mm	
013700540	180mm	
013700543	200 mm	
013700546	225 mm	
013700549	250 mm	
013700552	280 mm	
013700555	315 mm	
013700558	355mm	
013700561	400mm	
013700564	450mm	
013700567	500mm	
013700570	560 mm	
013700573	630 mm	

YEE 45° PE-100, EXT LARGOS, RD 11



codigo	MEDIDA	PRECIO
013700664	63 mm	
013700666	75 mm	
013700668	90 mm	
013700671	110 mm	

RED CONCENTRICA PE-100, EXT LARGOS, RD 11

CÓDIGO
DESCUENTO



CODIGO	MEDIDA	PRECIO
014900964	25/20 mm	
014900965	32/20 mm	
014900966	32/25 mm	
014900967	40/20 mm	
014900968	40/25 mm	
014900969	40/32 mm	
014900970	50/25 mm	
014900971	50/32 mm	
014900972	50/40 mm	
014900973	63/32 mm	
014900974	63/40 mm	
014900975	63/50 mm	
014900976	75/50 mm	
014900977	75/63 mm	
014900978	90/63 mm	
014900979	90/75 mm	
019700194	90/50 mm	
014900782	110/63 mm	
014900783	110/90 mm	
019700272	110/75 mm	
014900784	125/63 mm	
014900785	125/90 mm	
014900786	125/110 mm	
019700444	140/75 mm	
019700430	140/90 mm	
019700431	140/110 mm	
014900980	140/125 mm	
014900787	160/90 mm	
014900788	160/110 mm	
014900789	160/125 mm	
014900790	160/140 mm	
014900487	180/125 mm	
019700325	180/90 mm	
014900981	180/160 mm	
019700445	180/110 mm	
019700446	180/140 mm	
014900791	200/160 mm	
019700447	200/140 mm	
019700448	200/180 mm	
014900792	225/140 mm	
014900793	225/160 mm	
014900794	225/180 mm	
019700269	225/200 mm	
014901051	250/160 mm	
014901052	250/180 mm	
014901053	225/200 mm	
014901054	250/225 mm	
019700142	280/250 mm	
019700139	280/225 mm	
019700141	280/200 mm	
019700143	315/225 mm	
019700144	315/250 mm	
019700145	315/280 mm	

REDUCCION CONCENTRICA PE-100, EXT LARGOS, RD 11

FABRICADA

CÓDIGO
DESCUENTO



CODIGO	MEDIDA	PRECIO
010006432	450/280 mm	
010006433	450/315 mm	
010006434	450/355 mm	
010006435	450/400 mm	
010006436	500/315 mm	
010006437	500/355 mm	
010006438	500/400 mm	
010006439	500/450 mm	
010006440	560/355 mm	
010006442	560/400 mm	
010006443	560/450 mm	
010006444	560/500 mm	
010006445	630/400 mm	
010006446	630/450 mm	
010006447	630/500 mm	
010006448	630/500 mm	

CODO 90° RADIO LARGO, PE-100, RD 11

CÓDIGO
DESCUENTO



CÓDIGO	MEDIDA	PRECIO
010100537	20 mm	
010100538	25 mm	
010100539	32 mm	
010100540	40 mm	
010100541	50 mm	
010100542	63 mm	
010100543	75 mm	
010100544	90 mm	
010100545	110 mm	
010100546	125 mm	
010100547	140 mm	
010100548	160 mm	
010100549	180 mm	
010100550	200 mm	
010100551	225 mm	
010100552	250 mm	
010100553	280 mm	
010100554	315 mm	
010100555	355 mm	
010100556	400 mm	

STUB END PE-100 (PORTABRIDA) ISO/DIN, RD11

CÓDIGO
DESCUENTO



CÓDIGO	MEDIDA	PRECIO
010600341	20 mm	
010600342	25 mm	
010600343	32 mm	
010600344	40 mm	
010600345	50 mm	
010600346	63 mm	
010600347	75 mm	
010600348	90 mm	
010600349	110 mm	
010600350	125 mm	
010600351	140 mm	
010600352	160 mm	
010600147	180 mm	
010600353	200 mm	
010600354	225 mm	
010600148	250 mm	
010600355	280 mm	
010600356	315 mm	
010600151	355 mm	
010600154	400 mm	
010600357	450 mm	
010600358	500 mm	

STUB END PE-100 (PORTABRIDA) ISO/DIN, FABRICADA, RD11

CÓDIGO
DESCUENTO



codigo	MEDIDA	PRECIO
010600359	560 mm	
010600360	630 mm	

STUB END PE-100 (PORTABRIDA) ANSI, RD11

CÓDIGO
DESCUENTO



CÓDIGO	MEDIDA	PRECIO
010600874	20 mm	
010600875	25 mm	
010600876	32 mm	
010600877	40 mm	
010600878	50 mm	
010600879	63 mm	
010600880	75 mm	
010600881	90 mm	

TEE PE-100, RD 11

CÓDIGO
DESCUENTO



CODIGO	MEDIDA	PRECIO
010300336	20 mm	
010300337	25 mm	
010300338	32 mm	
010300339	40 mm	
010300340	50 mm	
010300341	63 mm	
010300342	75 mm	
010300343	90 mm	
010300344	110 mm	
010300345	125 mm	
010300346	140 mm	
010300347	160 mm	
010300348	180 mm	
010300349	200 mm	
010300350	225 mm	
010300122	250 mm	
010300351	280 mm	
010300352	315 mm	
010300353	355 mm	
010300354	400 mm	
010300934	450 mm	
010300903	500 mm	

TEE REDUCIDA PE-100, RD 11

CÓDIGO
DESCUENTO



CODIGO	MEDIDA	PRECIO
013500950	90/32 mm	
013500953	110/32 mm	
013500954	110/50 mm	
013500957	125/63 mm	
013500959	140/63 mm	
013500960	140/75 mm	
013500961	140/90 mm	
013500962	140/110 mm	
013500965	160/125 mm	
013500966	180/63 mm	
013500967	180/75 mm	
013500970	180/125 mm	
013500971	200/63 mm	
013500974	200/125 mm	
013500975	200/160 mm	
013500976	225/90 mm	
013500977	225/110 mm	
013500978	225/125 mm	
013500980	250/110 mm	
013500981	250/160 mm	

REDUCCION CONCENTRICA PE-100, RD 11



CODIGO	MEDIDA	PRECIO
014900885	25/20 mm	
014900886	32/20 mm	
014900887	32/25 mm	
014900889	40/25 mm	
014900890	40/32 mm	
014900888	40/20 mm	
014900891	50/25 mm	
014900892	50/32 mm	
014900893	50/40 mm	
014900894	63/32 mm	
014900895	63/40 mm	
014900896	63/50 mm	
014901062	75/40 mm	
014900897	75/32 mm	
014900898	75/50 mm	
014900899	75/63 mm	
014901063	90/75 mm	
014900900	90/50 mm	
014900901	90/63 mm	
014900902	110/50 mm	
014900903	110/63 mm	
014900904	110/75 mm	
014900905	110/90 mm	
014900906	125/63 mm	
014900907	125/75 mm	
014900908	125/90 mm	
014900909	125/110 mm	
014900910	140/75 mm	
014900911	140/90 mm	
014900912	140/110 mm	
014900913	140/125 mm	
014900914	160/90 mm	
014900915	160/110 mm	
014900916	160/125 mm	
014900917	160/140 mm	
014900918	180/90 mm	
014900919	180/110 mm	
014900920	180/125 mm	
014900921	180/140 mm	
014900922	180/160 mm	
014900923	200/140 mm	
014900924	200/160 mm	
014900925	200/180 mm	
014900926	225/140 mm	
014900927	225/160 mm	
014900928	225/180 mm	
014900929	225/200 mm	
014900930	225/160 mm	
014900931	250/180 mm	
014900932	250/200 mm	
014900933	250/225 mm	
014900934	280/200 mm	
014900935	280/225 mm	
014900936	280/250 mm	
014900937	315/200 mm	
014900938	315/225 mm	
014900986	315/250 mm	
014900939	315/280 mm	
014900940	355/225 mm	
014900941	355/250 mm	
014900942	355/280 mm	
014900943	355/315 mm	

CODIGO
DESCUENTO

REDUCCION CONCENTRICA FABRICADA PE-100, RD11



CODIGO	MEDIDA	PRECIO
014900944	400/225 mm	
014900945	400/250 mm	
014900946	400/280 mm	
014900947	400/315 mm	
014900948	400/355 mm	
014900949	450/280 mm	
014900950	450/315 mm	
014900951	450/355 mm	
014900952	450/400 mm	
014900953	500/315 mm	
014900954	500/355 mm	
014900955	500/400 mm	
014900956	500/450 mm	
014900957	560/400 mm	
014900958	560/450 mm	
014900959	560/500 mm	
014900960	630/400 mm	
014900961	630/450 mm	
014900962	630/500 mm	
014900963	630/560 mm	

CODIGO
DESCUENTO

REDUCCION EXCENTRICA PE-100, RD 11



CODIGO	MEDIDA	PRECIO
015000532	160/90 mm	
015000533	160/110 mm	
015000534	160/125 mm	
015000535	160/140 mm	
015000536	180/125 mm	
015000537	180/140 mm	
015000538	180/160 mm	
015000539	200/140 mm	
015000540	200/160 mm	
015000541	200/180 mm	
015000542	225/160 mm	
015000543	225/180 mm	
015000544	225/200 mm	
015000545	250/180 mm	
015000546	250/200 mm	
015000547	250/225 mm	
015000548	280/200 mm	
015000549	280/225 mm	
015000550	280/250 mm	
015000551	315/225 mm	
015000552	315/250 mm	
015000553	315/280 mm	
015000554	355/250 mm	
015000555	355/280 mm	
015000556	355/315 mm	
015000557	400/280 mm	
015000558	400/315 mm	
015000559	400/355 mm	
015000560	450/315 mm	
015000561	450/355 mm	
015000562	450/400 mm	
015000563	500/315 mm	
015000564	500/355 mm	
015000565	500/400 mm	
015000566	500/450 mm	
015000567	560/450 mm	
015000568	560/500 mm	
015000569	630/500 mm	
015000570	630/560 mm	

CODIGO
DESCUENTO

TAPON FABRICADO PE-100, RD 11



CODIGO	MEDIDA	PRECIO
013900244	250 mm	
013900247	280 mm	
013900250	315 mm	
013900253	355 mm	
013900256	400 mm	
013900259	450 mm	
013900262	500 mm	
013900265	560 mm	
013900268	630 mm	



TAPON ROSCADO



CODIGO	MEDIDA	PRECIO
	1/2"	
	3/4"	
	1"	
	1 1/2"	
	2"	
	2 1/2"	



RESTRICTOR (PARA ABRAZADERA) PE-100, RD 11



CODIGO	MEDIDA	PRECIO
015400095	50 mm	
015400096	63 mm	
015400097	75 mm	
015400098	90 mm	
015400099	110 mm	
015400100	125 mm	
015400101	140 mm	
015400102	160 mm	
015400103	180 mm	
015400104	200 mm	
015400105	225 mm	
015400106	250 mm	
015400107	280 mm	
015400108	315 mm	
015400109	355 mm	
015400110	400 mm	
015400111	450 mm	
015400112	500 mm	



COPLE ELECTROSOLDABLE PE-100, RD 17



CODIGO	MEDIDA	PRECIO
014300103	20 mm	
014300104	25 mm	
014300105	32 mm	
014300106	40 mm	
014300107	50 mm	
014300108	63 mm	
014300109	75 mm	
014300110	90 mm	
014300111	110 mm	
014300112	125 mm	
014300113	140 mm	
014300114	160 mm	
014300115	180 mm	
014300116	200 mm	
014300117	225 mm	
014300118	250 mm	
014300119	315 mm	
014300099	280 mm	
014300101	355 mm	
014300102	400 mm	
014300129	450 mm	
014300130	500 mm	
014300131	560 mm	
014300132	630 mm	
014300133	710 mm	

COPLE ELECTROSOLDABLE CON CANAL PE-100, RD 17



CODIGO	MEDIDA	PRECIO
014300012	110 mm	
014300013	125 mm	
014300065	140 mm	
014300014	160 mm	
014300015	180 mm	
014300016	200 mm	
014300017	225 mm	
014300018	250 mm	
014300019	280 mm	
014300020	315 mm	
014300021	355 mm	
014300022	400 mm	
014300023	450 mm	
014300024	500 mm	

SILLETA SOLDABLE PE-100, RD 17



CODIGO	MEDIDA	PRECIO
024100035	225 mm	
024100036	250 mm	
024100037	280 mm	
024100039	355 mm	
024100040	400 mm	
010006407	450 mm	
010006408	500 mm	
010006409	560 mm	

CODO 90° PE-100, EXT LARGOS, RD 17



CÓDIGO	MEDIDA	PRECIO
019200160	50 mm	
019200069	63 mm	
019200162	75 mm	
019200164	90 mm	
019200166	110 mm	
019200168	125 mm	
019200307	140 mm	
019200170	160 mm	
019200172	180 mm	
019200174	200 mm	
019200176	225 mm	
019200284	250 mm	
019200286	280 mm	
019200288	315 mm	

CODO 90° RADIO LARGO PE-100, EXT LARGOS, RD 17



CÓDIGO	MEDIDA	PRECIO
019100132	50 mm	
019100031	63 mm	
019100043	75 mm	
019100045	90 mm	
019100047	110 mm	
019100056	125 mm	
019100057	140 mm	
019100058	160 mm	
019100059	180 mm	
019100060	200 mm	
019100049	225 mm	
019100091	250 mm	
019100093	280 mm	
019100095	315 mm	

CODO 90° SIN COSTURA PE-100, EXT LARGOS, RD 17



CÓDIGO	MEDIDA	PRECIO
010101930	50 mm	
010101933	63 mm	
010101936	75 mm	
010101939	90 mm	
010101942	110 mm	
010101945	125 mm	
010101948	140 mm	
010101951	160 mm	
010101954	180 mm	
010101957	200 mm	
010101960	225 mm	
010101963	250 mm	
010101966	280 mm	
010101969	315 mm	
010102655	355 mm	
010102657	400 mm	
010102659	450 mm	
010102661	500 mm	
010102663	560 mm	
010102665	630 mm	

ABRAZADERA PE-100, RD 17

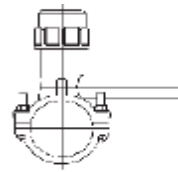

CODIGO	MEDIDA	PRECIO
015700042	40/20 mm	
015700043	40/32 mm	
015700044	50/20 mm	
015700045	50/32 mm	
015700046	63/20 mm	
015700047	63/32 mm	
015700048	63/40 mm	
015700049	63/50 mm	
015700050	63/63 mm	
015700051	75/32 mm	
015700052	75/40 mm	
015700053	75/50 mm	
015700054	75/63 mm	
015700055	90/32 mm	
015700056	90/40 mm	
015700057	90/50 mm	
015700058	90/63 mm	
015700059	110/32 mm	
015700060	110/40 mm	
015700061	110/50 mm	
015700062	110/63 mm	
015700063	125/32 mm	
015700064	125/40 mm	
015700065	125/50 mm	
015700066	125/63 mm	
015700067	140/32 mm	
015700068	140/40 mm	
015700069	140/50 mm	
015700070	140/63 mm	
015700071	160/32 mm	
015700072	160/40 mm	
015700073	160/50 mm	
015700074	160/63 mm	
015700075	180/32 mm	
015700076	180/40 mm	
015700077	180/50 mm	
015700078	180/63 mm	
015700079	200/32 mm	
015700080	200/40 mm	
015700081	200/50 mm	
015700082	200/63 mm	
015700083	225/32 mm	
015700084	225/40 mm	
015700085	225/50 mm	
015700086	225/63 mm	
015700087	250/32 mm	
015700088	250/40 mm	
015700089	250/50 mm	
015700090	250/63 mm	

CODO 60° SIN COSTURA PE-100, EXT LARGOS, RD 17



CÓDIGO	MEDIDA	PRECIO
010101761	50 mm	
010101764	63 mm	
010101767	75 mm	
010101770	90 mm	
010101773	110 mm	
010101776	125 mm	
010101779	140 mm	
010101782	160 mm	
010101785	180 mm	
010101788	200 mm	
010101791	225 mm	
010101794	250 mm	
010101797	280 mm	
010101800	315 mm	
010102667	355 mm	
010102669	400 mm	
010102671	450 mm	
010102673	500 mm	
010102675	560 mm	
010102677	630 mm	

CODO 60° PE-100 FABRICADO, EXT LARGOS, RD 17

CÓDIGO
DESCUENTO



CÓDIGO	MEDIDA	PRECIO
010101700	90 mm	
010101703	110 mm	
010101706	125 mm	
010101709	140 mm	
010101712	160 mm	
010101715	180 mm	
010101718	200 mm	
010101721	225 mm	
010101724	250 mm	
010101727	280 mm	
010101730	315 mm	
010101733	355 mm	
010101736	400 mm	
010101739	450 mm	
010101742	500 mm	
010101745	560 mm	
010101748	630 mm	
010101751	710 mm	
010101753	800 mm	
010101755	900 mm	
010101757	1000 mm	

CODO 90° PE-100 FABRICADO, EXT LARGOS RD 17

CÓDIGO
DESCUENTO



CÓDIGO	MEDIDA	PRECIO
010101845	90 mm	
010101848	110 mm	
010101851	125 mm	
010101854	140 mm	
010101857	160 mm	
010101860	180 mm	
010101863	200 mm	
010101866	225 mm	
010101869	250 mm	
010101872	280 mm	
010101875	315 mm	
010101878	355 mm	
010101881	400 mm	
010101884	450 mm	
010101887	500 mm	
010101890	560 mm	
010101893	630 mm	
010101896	710 mm	
010101898	800 mm	
010101900	900 mm	
010101902	1000 mm	

CODO 30° SIN COSTURA PE-100, EXT LARGOS, RD 17

CÓDIGO
DESCUENTO



CÓDIGO	MEDIDA	PRECIO
010101474	50 mm	
010101477	63 mm	
010101480	75 mm	
010101483	90 mm	
010101486	110 mm	
010101489	125 mm	
010101492	140 mm	
010101495	160 mm	
010101498	180 mm	
010101501	200 mm	
010101504	225 mm	
010101507	250 mm	
010100348	280 mm	
010101512	315 mm	
010102690	355 mm	
010102692	400 mm	
010102694	450 mm	
010102696	500 mm	
010102698	560 mm	
010102700	630 mm	

CODO 45° PE-100, EXT LARGOS RD 17

CÓDIGO
DESCUENTO



CÓDIGO	MEDIDA	PRECIO
019200189	50 mm	
019200191	63 mm	
019200193	75 mm	
019200195	90 mm	
019200197	110 mm	
019200199	125 mm	
019200378	140 mm	
019200200	160 mm	
019200202	180 mm	
019200204	200 mm	
019200206	225 mm	
019200278	250 mm	
019200280	280 mm	
019200282	315 mm	

CODO 30° PE-100 FABRICADO, EXT LARGOS RD 17

CÓDIGO
DESCUENTO



CÓDIGO	MEDIDA	PRECIO
010101415	90 mm	
010101418	110 mm	
010101421	125 mm	
010101424	140 mm	
010101427	160 mm	
010101430	180 mm	
010101433	200 mm	
010101436	225 mm	
010101439	250 mm	
010101442	280 mm	
010101445	315 mm	
010101448	355 mm	
010100101	400 mm	
010100102	450 mm	
010101455	500 mm	
010101458	560 mm	
010101461	630 mm	
010101464	710 mm	
010101466	800 mm	
010101468	900 mm	
010101470	1000 mm	

CODO 45° SIN COSTURA PE-100, EXT LARGOS RD 17

CÓDIGO
DESCUENTO



CODIGO	MEDIDA	PRECIO
010101618	50 mm	
010101621	63 mm	
010101624	75 mm	
010101627	90 mm	
010101630	110 mm	
010101633	125 mm	
010101636	140 mm	
010101639	160 mm	
010101642	180 mm	
010101645	200 mm	
010102790	225 mm	
010101650	250 mm	
010100336	280 mm	
010101655	315 mm	
010102679	355 mm	
010102680	400 mm	
010102682	450 mm	
010102684	500 mm	
010102686	560 mm	
010102688	630 mm	

**STUB END PE-100 (PORTABRIDA) ISO/DIN, RD 17
FABRICADO, EXT LARGOS**

CÓDIGO
DESCUENTO



CÓDIGO	MEDIDA	PRECIO
010006415	450 mm	
010006416	500 mm	
010006417	560 mm	
010006418	630 mm	

CODO 45° PE-100 FABRICADO, EXT LARGOS RD 17

CÓDIGO
DESCUENTO



CÓDIGO	MEDIDA	PRECIO
010101560	110 mm	
010101563	125 mm	
010101566	140 mm	
010101569	160 mm	
010101572	180 mm	
010101575	200 mm	
010101578	225 mm	
010101581	250 mm	
010101584	280 mm	
010101587	315 mm	
010101590	355 mm	
010101593	400 mm	
010101596	450 mm	
010101599	500 mm	
010101602	560 mm	
010101605	630 mm	
010101608	710 mm	
010101610	800 mm	
010101612	900 mm	
010101614	1000 mm	

**STUB END PE-100 (PORTABRIDA) ISO/DIN, RD 17
EXT LARGOS**

CÓDIGO
DESCUENTO



CÓDIGO	MEDIDA	PRECIO
019400107	50 mm	
019400119	63 mm	
019400109	75 mm	
019400121	90 mm	
019400122	110 mm	
019400123	125 mm	
019400110	140 mm	
019400042	160 mm	
019400045	180 mm	
019400126	200 mm	
019400049	225 mm	
019400128	250 mm	
019400131	280 mm	
019400133	315 mm	
019400191	355 mm	
019400193	400 mm	

TEE FABRICADA PE-100, EXT LARGOS, RD 17



CODIGO	MEDIDA	PRECIO
010300657	90 mm	
010300660	110 mm	
010300663	125 mm	
010300666	140 mm	
010300669	160 mm	
010300672	180 mm	
010300675	200 mm	
010300678	225 mm	
010300681	250 mm	
010300684	280 mm	
010300687	315 mm	
010300690	355 mm	
010300693	400 mm	
010300696	450 mm	
010300699	500 mm	
010300702	560 mm	
010300705	630 mm	
010300708	710 mm	
010300710	800 mm	

CODIGO
DESCUENTO

CODO 22° SIN COSTURA PE-100, EXT LARGOS RD 17

CODIGO	MEDIDA	PRECIO
010102704	50 mm	
010102706	63 mm	
010102708	75 mm	
010102376	90 mm	
010102378	110 mm	
010102380	125 mm	
010102382	140 mm	
010102383	160 mm	
010102385	180 mm	
010102711	200 mm	
010102387	225 mm	
010102713	250 mm	
010102391	280 mm	
010102715	315 mm	
010102716	355 mm	
010102718	400 mm	
010102720	450 mm	
010102722	500 mm	
010102724	560 mm	
010102726	630 mm	

CODIGO
DESCUENTO

TEE FABRICADA/REFORZADA PE-100, EXT LARGOS, RD 17



CÓDIGO	MEDIDA	PRECIO
010006430	560 mm	
010006431	630 mm	

CODIGO
DESCUENTO

CODO 11° SIN COSTURA PE-100, EXT LARGOS, RD 17

CODIGO	MEDIDA	PRECIO
010102730	32 mm	
010102732	40 mm	
010102734	50 mm	
010102360	63 mm	
010102362	75 mm	
010102364	90 mm	
010102366	110 mm	
010102367	125 mm	
010102369	140 mm	
010102737	160 mm	
010102371	180 mm	
010102739	200 mm	
010102373	225 mm	
010102742	250 mm	
010102744	280 mm	
010102746	315 mm	
010102748	355 mm	
010102750	400 mm	
010102752	450 mm	
010102754	500 mm	

CODIGO
DESCUENTO

TEE PE-100, EXT LARGOS, RD 17



CÓDIGO	MEDIDA	PRECIO
010300594	50 mm	
010300596	63 mm	
010300598	75 mm	
010300599	90 mm	
010300601	110 mm	
010300603	125 mm	
010300604	140 mm	
010300606	160 mm	
010300607	180 mm	
010300608	200 mm	
010300725	225 mm	
010300726	250 mm	
010300610	280 mm	
010300612	315 mm	
019300086	355mm	
019300088	400mm	
019300205	450mm	
019300207	500mm	

CODIGO
DESCUENTO

TEE REDUCIDA FABRICADA PE-100, EXT LARGOS, RD 17



CODIGO	MEDIDA	PRECIO
010010529	90/40 mm	
013500701	90/50 mm	
010010530	110/40 mm	
013500703	110/50 mm	
013500704	110/63 mm	
010010531	125/40 mm	
013500706	125/50 mm	
013500707	125/63 mm	
013500708	125/75 mm	
013500710	140/63 mm	
013500711	140/75 mm	
013500712	140/90 mm	
013500714	160/63 mm	
013500715	160/75 mm	
013500716	160/90 mm	
013500717	160/110 mm	
013500753	355/110 mm	
013500718	180/75 mm	
013500719	180/90 mm	
013500720	180/110 mm	
013500721	180/140 mm	
013500722	200/75 mm	
013500723	200/90 mm	
013500724	200/110 mm	
013500725	200/140 mm	
013500727	225/75 mm	
013500728	225/90 mm	
013500729	225/110 mm	
013500730	225/140 mm	
013500731	225/160 mm	
013500732	225/180 mm	
013500733	250/90 mm	
013500734	250/110 mm	
013500735	250/140 mm	
013500736	250/160 mm	
013500737	250/180 mm	
013500739	280/90 mm	
013500740	280/110 mm	
013500741	280/140 mm	
013500742	280/160 mm	
013500743	280/180 mm	
013500746	315/110 mm	
013500749	315/180 mm	
013500754	355/140 mm	
013500769	450/140 mm	
013500761	400/140 mm	
013500747	315/140 mm	
013500777	500/160 mm	
013500748	315/160 mm	
013500755	355/160 mm	
013500770	450/160 mm	
013500762	400/160 mm	
013500726	200/160 mm	
013500786	560/180 mm	
013500763	400/180 mm	
013500778	500/180 mm	
013500771	450/180 mm	
013500756	355/180 mm	
013500738	250/200 mm	
013500772	450/200 mm	
013500757	355/200 mm	

TEE REDUCIDA FABRICADA PE-100, EXT LARGOS, RD 17



CODIGO	MEDIDA	PRECIO
013500787	560/200 mm	
013500779	500/200 mm	
013500764	400/200 mm	
013500744	280/200 mm	
013500794	630/200 mm	
013500750	315/200 mm	
013500745	280/225 mm	
013500780	500/225 mm	
013500795	630/225 mm	
013500751	315/225 mm	
013500758	355/225 mm	
013500773	450/225 mm	
013500788	560/225 mm	
013500765	400/225 mm	
013500789	560/250 mm	
013500774	450/250 mm	
013500766	400/250 mm	
013500781	500/250 mm	
013500752	315/250 mm	
013500759	355/250 mm	
013500760	355/280 mm	
013500775	450/280 mm	
013500790	560/280 mm	
013500767	400/280 mm	
013500782	500/280 mm	
013500797	630/280 mm	
013500768	400/315 mm	
013500798	630/315 mm	
013500783	500/315 mm	
013500776	450/315 mm	
013500791	560/315 mm	
013500792	560/355 mm	
013500784	500/355 mm	
013500799	630/355 mm	
013500796	630/250 mm	
013500800	630/400 mm	
013500793	560/400 mm	
010010532	140/40 mm	
010010533	140/50 mm	
010010534	160/50 mm	
010010574	160/125 mm	
010010535	180/50 mm	
010010536	180/63 mm	
013501048	180/125 mm	
010010537	200/63 mm	
010010575	200/125 mm	
010010538	225/63 mm	
010010539	225/125 mm	
010010540	250/63 mm	
010010541	250/75 mm	
010010542	250/125 mm	
013501049	280/125 mm	
010010543	315/90 mm	
010010544	315/125 mm	
010010545	355/90 mm	
010010546	355/125 mm	
010010547	400/90 mm	
010010548	400/110 mm	
010010576	400/125 mm	
010010549	450/110 mm	
010010550	450/125 mm	

TEE REDUCIDA FABRICADA PE-100, EXT LARGOS, RD 17



CODIGO	MEDIDA	PRECIO
010010551	500/110 mm	
010010552	500/125 mm	
010010553	500/140 mm	
013501050	560/160 mm	
010010554	630/160 mm	
010010555	630/180 mm	
013500801	630/450 mm	
010010556	710/160 mm	
010010557	710/180 mm	
010010558	710/200 mm	
010010559	710/225 mm	
010010560	710/250 mm	
010010561	710/280 mm	
010010562	710/315 mm	
010010563	710/355 mm	
010010564	710/400 mm	
010010565	800/160 mm	
010010566	800/180 mm	
010010567	800/200 mm	
010010568	800/225 mm	
010010569	800/250 mm	
010010570	800/280 mm	
010010571	800/315 mm	
010010572	800/355 mm	
010010573	800/400 mm	

TEE REDUCIDA PE-100, EXT LARGOS, RD 17



CODIGO	MEDIDA	PRECIO
013500834	63/50 mm	
013500836	75/50 mm	
013500837	75/63 mm	
013500685	90/50 mm	
013500686	90/63 mm	
013500838	90/75 mm	
013500687	110/63 mm	
013500688	110/90 mm	
013500839	110/75 mm	
013500840	125/110 mm	
013500689	160/90 mm	
013500690	160/110 mm	
013500841	160/63 mm	
013500842	160/75 mm	
013500843	180/160 mm	
022300057	200/63 mm	
022300058	200/90 mm	
022300059	200/110 mm	
022300060	200/160 mm	
013500110	225/110 mm	
013500111	225/160 mm	
013500691	225/90 mm	
013500844	225/75 mm	
013500845	225/180 mm	
022300121	250/110 mm	
022300122	250/160 mm	
022300098	315/110 mm	
022300099	315/160 mm	
022300123	315/250 mm	

TAPA PE-100, EXT LARGOS, RD 17



CODIGO	MEDIDA	PRECIO
013900319	50 mm	
013900322	63 mm	
013900325	75 mm	
013900328	90 mm	
013900331	110 mm	
013900334	125 mm	
013900337	140 mm	
013900340	160 mm	
013900343	180 mm	
013900346	200 mm	
013900349	225 mm	
019600054	250 mm	
019600055	280 mm	
019600061	315 mm	
019600057	355mm	
019600059	400mm	

YEE 60° FABRICADA PE-100, EXT LARGOS, RD 17



CODIGO	MEDIDA	PRECIO
013700575	110mm	
013700578	125mm	
013700581	140mm	
013700584	160mm	
013700587	180mm	
013700590	200 mm	
013700593	225 mm	
013700596	250 mm	
013700599	280 mm	
013700602	315 mm	
013700605	355mm	
013700608	400mm	
013700611	450mm	
013700614	500mm	
013700617	560 mm	
013700620	630 mm	

REDUCCION CONCENTRICA PE-100, EXT LARGOS, RD 17



CODIGO	MEDIDA	PRECIO
019700195	50/25 mm	
019700196	50/32 mm	
019700197	50/40 mm	
019700198	63/32 mm	
019700199	63/40 mm	
019700200	63/50 mm	
014900879	75/63 mm	
019700202	90/50 mm	
014900881	90/75 mm	
014900880	90/63 mm	
014900795	110/63 mm	
014900796	110/90 mm	
019700273	110/75 mm	
014900798	125/90 mm	
014900797	125/63 mm	
014900799	125/110 mm	
019700440	140/75 mm	
019700432	140/90 mm	
019700222	140/110 mm	
014900882	140/125 mm	
014900800	160/90 mm	
014900802	160/140 mm	
014900211	160/110 mm	
014900801	160/125 mm	
019700326	180/90 mm	
014900884	180/160 mm	
014900883	180/125 mm	
019700441	180/110 mm	
019700223	180/140 mm	
014900212	200/160 mm	
019700442	200/140 mm	
019700224	200/180 mm	
014900803	225/140 mm	
014900213	225/160 mm	
014900804	225/180 mm	
019700443	225/200 mm	
014901043	250/160 mm	
014901045	250/200 mm	
014901046	250/225 mm	
014901044	250/180 mm	
019700146	280/200 mm	
019700140	280/225 mm	
019700147	280/250 mm	
019700148	315/225 mm	
019700134	315/250 mm	
019700159	315/280 mm	
019700239	355/250 mm	
019700241	355/315 mm	
019700240	355/280 mm	
019700238	400/355 mm	
019700242	400/280 mm	
019700243	400/315 mm	

YEE 45° FABRICADA PE-100, EXT LARGOS, RD 17



CODIGO	MEDIDA	PRECIO
013700527	110mm	
013700530	125mm	
013700533	140mm	
013700536	160mm	
013700539	180mm	
013700542	200 mm	
013700545	225 mm	
013700548	250 mm	
013700551	280 mm	
013700554	315 mm	
013700557	355mm	
013700560	400mm	
013700563	450mm	
013700566	500mm	
013700569	560 mm	
013700572	630 mm	

YEE 45° INYECTADA PE-100, EXT LARGOS, RD 17



codigo	MEDIDA	PRECIO
013700663	63 mm	
013700665	75 mm	
013700667	90 mm	
013700670	110 mm	

RED. CONCENTRICA FAB PE-100, EXT LARGOS, RD 17



CODIGO	MEDIDA	PRECIO
010006449	450/280 mm	
010006450	450/315 mm	
010006451	450/355 mm	
010006452	450/400 mm	
010006453	500/315 mm	
010006454	500/355 mm	
010006455	500/400 mm	
010006456	500/450 mm	
010006457	560/355 mm	
010006458	560/400 mm	
010006459	560/450 mm	
010006460	560/500 mm	
010006461	630/400 mm	
010006462	630/450 mm	
010006463	630/500 mm	
010006464	630/500 mm	

TAPA FABRICADO PE-100, EXT LARGOS, RD 17



CODIGO	MEDIDA	PRECIO
010006424	450 mm	
010006425	500 mm	
010006426	560 mm	
010006427	630 mm	

CODO 90° RADIO LARGO PE-100, RD 17.6



CODIGO	MEDIDA	PRECIO
010101903	50 mm	
010101904	63 mm	
010101905	75 mm	
010101906	90 mm	
010101908	110 mm	
010101910	125 mm	
010101912	140 mm	
010101914	160 mm	
010101916	180 mm	
010101918	200 mm	
010102017	225 mm	
010101921	250 mm	
010102018	280 mm	
010101924	315 mm	
010102037	355 mm	
010101926	400 mm	

STUB END PE-100 (PORTABRIDA) ISO/DIN, RD 17



CODIGO	MEDIDA	PRECIO
010600319	50 mm	
010600320	63 mm	
010600321	75 mm	
010600322	90 mm	
010600323	110 mm	
010600324	125 mm	
010600325	140 mm	
010600326	160 mm	
010600327	180 mm	
010600328	200 mm	
010600329	225 mm	
010600330	250 mm	
010600331	280 mm	
010600332	315 mm	
010600150	355 mm	
010600153	400 mm	
010600333	450 mm	
010600334	500 mm	
010600335	560 mm	
010600336	630 mm	

STUB END PE-100 (PORTABRIDA) ISO/DIN, FABRICADA, RD 17



CODIGO	MEDIDA	PRECIO
010600337	710 mm	
010600338	800 mm	
010600339	900 mm	
010600340	1000 mm	

TEE REDUCIDA PE-100, RD 17



CODIGO	MEDIDA	PRECIO
013500802	90/32 mm	
013500805	110/32 mm	
013500806	110/50 mm	
013500811	140/63 mm	
013500812	140/75 mm	
013500813	140/90 mm	
013500814	140/110 mm	
013500817	160/125 mm	
013500818	180/63 mm	
013500819	180/75 mm	
013500822	180/125 mm	
013500823	200/63 mm	
013500826	200/125 mm	
013500827	200/160 mm	
013500828	225/90 mm	
013500829	225/110 mm	
013500830	225/125 mm	
013500832	250/110 mm	
013500833	250/160 mm	

TEE PE-100, RD17



CODIGO	MEDIDA	PRECIO
010300615	50 mm	
010300617	63 mm	
010300619	75 mm	
010300621	90 mm	
010300624	110 mm	
010300627	125 mm	
010300630	140 mm	
010300633	160 mm	
010300636	180 mm	
010300639	200 mm	
010300642	225 mm	
010300645	250 mm	
010300647	280 mm	
010300650	315 mm	
010300652	355 mm	
010300655	400 mm	
010300950	450 mm	
010300951	500 mm	

REDUCCION CONCENTRICA PE-100, RD 17

CÓDIGO
DESCUENTO



CODIGO	MEDIDA	PRECIO
014900814	63/50 mm	
014900817	75/50 mm	
014900818	75/63 mm	
014900819	90/50 mm	
014900820	90/63 mm	
014900821	90/75 mm	
014900822	110/50 mm	
014900823	110/63 mm	
014900824	110/75 mm	
014900825	110/90 mm	
014900826	125/63 mm	
014900827	125/75 mm	
014900828	125/90 mm	
014900829	125/110 mm	
014900470	140/110 mm	
014900471	140/125 mm	
014900830	140/75 mm	
014900831	140/90 mm	
014900832	160/90 mm	
014900833	160/110 mm	
014900834	160/125 mm	
014900835	160/140 mm	
014900472	180/125 mm	
014900836	180/90 mm	
014900837	180/110 mm	
014900838	180/140 mm	
014900839	180/160 mm	
014900840	200/140 mm	
014900841	200/160 mm	
014900842	200/180 mm	
014900473	225/200 mm	
014900843	225/140 mm	
014900844	225/160 mm	
014900845	225/180 mm	
014900846	250/160 mm	
014900847	250/180 mm	
014900848	250/200 mm	
014900849	250/225 mm	

REDUCCION CONCENTRICA FABRICADA PE-100, RD 17

CÓDIGO
DESCUENTO



CODIGO	MEDIDA	PRECIO
014900474	280/250 mm	
014901047	280/225 mm	
014900850	280/200 mm	
014900475	315/250 mm	
014900851	315/200 mm	
014900852	315/225 mm	
014901048	315/280 mm	
014900853	355/225 mm	
014900854	355/250 mm	
014900855	355/280 mm	
014900856	355/315 mm	
014900476	400/225 mm	
014900857	400/250 mm	
014900858	400/355 mm	
014900984	400/280 mm	
014900985	400/315 mm	
014900859	450/280 mm	
014900860	450/315 mm	
014900861	450/355 mm	
014900862	450/400 mm	
014901049	500/400 mm	
014900863	500/315 mm	
014900864	500/355 mm	
014900865	500/450 mm	
014900866	560/400 mm	
014900867	560/450 mm	
014900868	560/500 mm	
014901050	630/500 mm	
014900869	630/400 mm	
014900870	630/450 mm	
014900871	630/560 mm	
014900872	710/500 mm	
014900873	710/650 mm	
014900874	710/630 mm	
014900875	800/560 mm	
014900876	800/630 mm	
014900877	800/710 mm	

REDUCCION EXCENTRICA PE-100, RD 17

CÓDIGO
DESCUENTO



CODIGO	MEDIDA	PRECIO
015000463	160/90 mm	
015000464	160/110 mm	
015000465	160/125 mm	
015000466	160/140 mm	
015000467	180/125 mm	
015000468	180/140 mm	
015000469	180/160 mm	
015000470	200/140 mm	
015000471	200/160 mm	
015000472	200/180 mm	
015000473	225/160 mm	
015000474	225/180 mm	
015000475	225/200 mm	
015000476	250/180 mm	
015000477	250/200 mm	
015000478	250/225 mm	
015000479	280/200 mm	
015000480	280/225 mm	
015000481	280/250 mm	
015000482	315/225 mm	
015000483	315/250 mm	
015000484	315/280 mm	

REDUCCION EXCENTRICA PE-100, RD 17

CÓDIGO
DESCUENTO



CODIGO	MEDIDA	PRECIO
015000485	355/250 mm	
015000486	355/280 mm	
015000487	355/315 mm	
015000488	400/280 mm	
015000489	400/315 mm	
015000490	400/355 mm	
015000491	450/315 mm	
015000492	450/355 mm	
015000493	450/400 mm	
015000494	500/315 mm	
015000495	500/355 mm	
015000496	500/400 mm	
015000497	500/450 mm	
015000498	560/450 mm	
015000499	560/500 mm	
015000500	630/500 mm	
015000501	630/560 mm	
015000502	710/630 mm	
015000503	800/710 mm	
015000504	900/800 mm	
015000505	1000/900 mm	

TAPON FABRICADO PE-100 RD 17



CODIGO	MEDIDA	PRECIO
013900243	250 mm	
013900246	280 mm	
013900249	315 mm	
013900252	355 mm	
013900255	400 mm	
013900258	450 mm	
013900261	500 mm	
013900264	560 mm	
013900267	630 mm	
013900270	710 mm	
013900272	800 mm	



RESTRICTOR (PARA ABRAZADERA) PE-100, RD 17



CODIGO	MEDIDA	PRECIO
015400077	50 mm	
015400078	63 mm	
015400079	75 mm	
015400080	90 mm	
015400081	110 mm	
015400082	125 mm	
015400083	140 mm	
015400084	160 mm	
015400085	180 mm	
015400086	200 mm	
015400087	225 mm	
015400088	250 mm	
015400089	280 mm	
015400090	315 mm	
015400091	355 mm	
015400092	400 mm	
015400093	450 mm	
015400094	500 mm	



COPLE ELECTROSOLDABLE CON CANAL PE-100, RD 33



CODIGO	MEDIDA	PRECIO
014300012	110 mm	
014300013	125 mm	
014300065	140 mm	
014300014	160 mm	
014300015	180 mm	
014300016	200 mm	
014300017	225 mm	
014300018	250 mm	
014300019	280 mm	
014300020	315 mm	
014300021	355 mm	
014300022	400 mm	
014300023	450 mm	
014300024	500 mm	

CÓDIGO
DESCUENTO

SILLETA SOLDABLE PE-100, RD 33



CODIGO	MEDIDA	PRECIO
024100035	225 mm	
024100036	250 mm	
024100037	280 mm	
024100039	355 mm	
024100040	400 mm	
010006407	450 mm	
010006408	500 mm	
010006409	560 mm	

CÓDIGO
DESCUENTO

YEE 45° PE-100, EXT LARGOS, RD 33



codigo	MEDIDA	PRECIO
013700669	110 mm	

CÓDIGO
DESCUENTO

CODO 60° PE-100 FABRICADO, EXT LARGOS, RD 33



CÓDIGO	MEDIDA	PRECIO
010101699	90 mm	
010101702	110 mm	
010101705	125 mm	
010101708	140 mm	
010101711	160 mm	
010101714	180 mm	
010101717	200 mm	
010101720	225 mm	
010101723	250 mm	
010101726	280 mm	
010101729	315 mm	
010101732	355 mm	
010101735	400 mm	
010101738	450 mm	
010101741	500 mm	
010101744	560 mm	
010101747	630 mm	
010101750	710 mm	
010101752	800 mm	
010101754	900 mm	
010101756	1000 mm	

CÓDIGO
DESCUENTO

ABRAZADERA PE-100, RD 33

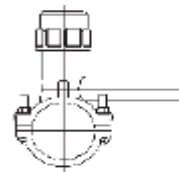

CODIGO	MEDIDA	PRECIO
015700042	40/20 mm	
015700043	40/32 mm	
015700044	50/20 mm	
015700045	50/32 mm	
015700046	63/20 mm	
015700047	63/32 mm	
015700048	63/40 mm	
015700049	63/50 mm	
015700050	63/63 mm	
015700051	75/32 mm	
015700052	75/40 mm	
015700053	75/50 mm	
015700054	75/63 mm	
015700055	90/32 mm	
015700056	90/40 mm	
015700057	90/50 mm	
015700058	90/63 mm	
015700059	110/32 mm	
015700060	110/40 mm	
015700061	110/50 mm	
015700062	110/63 mm	
015700063	125/32 mm	
015700064	125/40 mm	
015700065	125/50 mm	
015700066	125/63 mm	
015700067	140/32 mm	
015700068	140/40 mm	
015700069	140/50 mm	
015700070	140/63 mm	
015700071	160/32 mm	
015700072	160/40 mm	
015700073	160/50 mm	
015700074	160/63 mm	
015700075	180/32 mm	
015700076	180/40 mm	
015700077	180/50 mm	
015700078	180/63 mm	
015700079	200/32 mm	
015700080	200/40 mm	
015700081	200/50 mm	
015700082	200/63 mm	
015700083	225/32 mm	
015700084	225/40 mm	
015700085	225/50 mm	
015700086	225/63 mm	
015700087	250/32 mm	
015700088	250/40 mm	
015700089	250/50 mm	
015700090	250/63 mm	

CÓDIGO
DESCUENTO

CODO 30° PE-100 FABRICADO, EXT LARGOS, RD 33



CÓDIGO	MEDIDA	PRECIO
010101414	90 mm	
010101417	110 mm	
010101420	125 mm	
010101423	140 mm	
010101426	160 mm	
010101429	180 mm	
010101432	200 mm	
010101435	225 mm	
010101438	250 mm	
010101441	280 mm	
010101444	315 mm	
010101447	355 mm	
010101450	400 mm	
010101452	450 mm	
010101454	500 mm	
010101457	560 mm	
010101460	630 mm	
010101463	710 mm	
010101465	800 mm	
010101467	900 mm	
010101469	1000 mm	

CODO 90° PE-100 FABRICADO, EXT LARGOS, RD 33



CÓDIGO	MEDIDA	PRECIO
010101844	90 mm	
010101847	110 mm	
010101850	125 mm	
010101853	140 mm	
010101856	160 mm	
010101859	180 mm	
010101862	200 mm	
010101865	225 mm	
010101868	250 mm	
010101871	280 mm	
010101874	315 mm	
010101877	355 mm	
010101880	400 mm	
010101883	450 mm	
010101886	500 mm	
010101889	560 mm	
010101892	630 mm	
010101895	710 mm	
010101897	800 mm	
010101899	900 mm	
010101901	1000 mm	

CODO 45° PE-100 FABRICADO, EXT LARGOS, RD 33



CÓDIGO	MEDIDA	PRECIO
010101559	110 mm	
010101562	125 mm	
010101565	140 mm	
010101568	160 mm	
010101571	180 mm	
010101574	200 mm	
010101577	225 mm	
010101580	250 mm	
010101583	280 mm	
010101586	315 mm	
010101589	355 mm	
010101592	400 mm	
010101595	450 mm	
010101598	500 mm	
010101601	560 mm	
010101604	630 mm	
010101607	710 mm	
010101609	800 mm	
010101611	900 mm	
010101613	1000 mm	

CODO 90° RADIO LARGO PE-100, RD33



CODIGO	MEDIDA	PRECIO
010101907	110 mm	
010101909	125 mm	
010101911	140 mm	
010101913	160 mm	
010101915	180 mm	
010101917	200 mm	
010101919	225 mm	
010101920	250 mm	
010101922	280 mm	
010101923	315 mm	
010100557	355 mm	
010101925	400 mm	



REDUCCION EXCENTRICA PE-100, RD 33



CODIGO	MEDIDA	PRECIO
015000605	160/90 mm	
015000606	160/110 mm	
015000607	160/125 mm	
015000608	160/140 mm	
015000609	180/125 mm	
015000610	180/140 mm	
015000611	180/160 mm	
015000612	200/140 mm	
015000613	200/160 mm	
015000614	200/180 mm	
015000615	225/160 mm	
015000616	225/180 mm	
015000617	225/200 mm	
015000618	250/180 mm	
015000619	250/200 mm	
015000620	250/225 mm	
015000621	280/200 mm	
015000622	280/225 mm	
015000623	280/250 mm	
015000624	315/225 mm	
015000625	315/250 mm	
015000626	315/280 mm	
015000627	355/250 mm	
015000628	355/280 mm	
015000629	355/315 mm	
015000630	400/280 mm	
015000631	400/315 mm	
015000632	400/355 mm	
015000634	450/315 mm	
015000635	450/355 mm	
015000633	450/400 mm	
015000636	500/315 mm	
015000637	500/355 mm	
015000638	500/400 mm	
015000639	500/450 mm	
015000640	560/450 mm	
015000641	560/500 mm	
015000642	630/500 mm	
015000643	630/560 mm	
015000644	710/630 mm	
015000645	800/710 mm	
015000646	900/800 mm	
015000647	1000/900 mm	



STUB END PE-100 (PORTABRIDA) ISO/DIN, RD 33



CODIGO	MEDIDA	PRECIO
010600378	110 mm	
010600380	125 mm	
010600382	140 mm	
010600384	160 mm	
010600385	180 mm	
010600387	200 mm	
010600389	225 mm	
010600391	250 mm	
010600393	280 mm	
010600394	315 mm	
010600395	355 mm	
010600396	400 mm	
010600397	450 mm	
010600399	500 mm	
010600401	560 mm	
010600403	630 mm	
010600405	710 mm	
010600407	800 mm	
010600409	900 mm	
010600411	1000 mm	



STUB END PE-100 (PORTABRIDA) ISO/DIN, FABRICADA RD 33



CODIGO	MEDIDA	PRECIO
010600405	710 mm	
010600407	800 mm	
010600409	900 mm	
010600411	1000 mm	



TEE PE-100, RD 33



CODIGO	MEDIDA	PRECIO
010300622	110 mm	
010300625	125 mm	
010300628	140 mm	
010300631	160 mm	
010300634	180 mm	
010300637	200 mm	
010300640	225 mm	
010300643	250 mm	
010300646	280 mm	
010300648	315 mm	
010300651	355 mm	
010300653	400 mm	



ARO PARA BRIDA ACERO/PP-HG, ISO/DIN RD 11, NEGRO



CÓDIGO	MEDIDA	PRECIO
013000021	20 mm	
013000022	25 mm	
013000023	32 mm	
013000024	40 mm	
013000025	50 mm	
013000026	63 mm	
013000027	75 mm	
013000028	90 mm	
013000029	110 mm	
013000030	125 mm	
013000031	140 mm	
013000032	160 mm	
013000033	180 mm	

ARO PARA BRIDA ACERO/PP-HG, ISO/DIN RD 17, NEGRO



CÓDIGO	MEDIDA	PRECIO
013000034	200 mm	
013000035	225 mm	
013000036	250 mm	
013000037	280 mm	
013000038	315 mm	
013000039	355 mm	
013000040	400 mm	
013000041	450 mm	
013000042	500 mm	

ARO PARA BRIDA ACERO/PP-HG, ANSI 150 lbs, GRIS



CÓDIGO	MEDIDA	PRECIO
013000047	½" (20 mm)	
013000048	¾" (25 mm)	
013000049	1" (32 mm)	
013000050	1¼" (40 mm)	
013000051	1½" (50 mm)	
013000052	2" (63 mm)	
013000053	2½" (75 mm)	
013000054	3" (90 mm)	
013000055	4" (110 mm)	
013000056	6" (160 mm)	
013000057	8" (200 mm)	
013000058	10" (250 mm)	
013000059	12" (315 mm)	
013000074	14" (355 mm)	
013000209	16" (400 mm)	

EMPAQUE PARA BRIDA, FPM RD 21



CODIGO	MEDIDA	PRECIO
016900037	20 mm	
016900038	25 mm	
016900039	32 mm	
016900040	40 mm	
016900041	50 mm	
016900042	63 mm	
016900043	75 mm	
016900044	90 mm	
016900045	110 mm	

EMPAQUE PERFILADO ACERO/FPM RD 21



CODIGO	MEDIDA	PRECIO
017000064	25 mm	
017000065	32 mm	
017000066	40 mm	
017000067	50 mm	
017000068	63 mm	
017000069	75 mm	
017000070	90 mm	
017000071	110 mm	
017000072	140 mm	
017000073	160 mm	
017000074	200 mm	
017000075	225 mm	

BRIDA CIEGA ACERO/PP-HG, ISO/DIN RD 11



CODIGO	MEDIDA	PRECIO
013100003	20 mm	
013100004	25 mm	
013100005	32 mm	
013100006	40 mm	
013100007	50 mm	
013100008	63 mm	
013100009	75 mm	
013100010	90 mm	
013100011	110 mm	
013100012	125 mm	
013100013	140 mm	
013100014	160 mm	
013100015	180 mm	

BRIDA CIEGA ACERO/PP-HG, ISO/DIN RD 17



CODIGO	MEDIDA	PRECIO
013100016	200 mm	
013100017	225 mm	
013100018	250 mm	
013100019	280 mm	
013100020	315 mm	
013100021	355 mm	
013100022	400 mm	

EMPAQUE EPDM RD 11



CODIGO	MEDIDA	PRECIO
016900015	20 mm	
016900034	25 mm	
016900016	32 mm	
016900017	40 mm	
016900018	50 mm	
016900019	63 mm	
016900020	75 mm	
016900021	90 mm	
016900022	110 mm	
016900023	125 mm	
016900024	140 mm	
016900025	160 mm	
016900026	180 mm	
016900027	200 mm	
016900028	225 mm	
016900029	250 mm	
016900030	280 mm	
016900031	315 mm	
016900032	355 mm	
016900033	400 mm	
016900046	450 mm	
016900082	500 mm	
016900083	560 mm	
016900078	630 mm	



EMPAQUE EPDM RD 17 Y 17.6



CODIGO	MEDIDA	PRECIO
016900047	50 mm	
016900048	63 mm	
016900049	75 mm	
016900050	90 mm	
016900051	110 mm	
016900052	125 mm	
016900053	140 mm	
016900054	160 mm	
016900055	180 mm	
016900056	200 mm	
016900057	225 mm	
016900058	250 mm	
016900059	280 mm	
016900060	315 mm	
016900061	355 mm	
016900062	400 mm	
016900084	450 mm	
016900087	500 mm	
016900088	560 mm	
016900089	630 mm	
016900090	710 mm	
016900091	800 mm	
016900092	900 mm	
016900093	1000 mm	



EMPAQUE PERFILADO ACERO/EPDM RD 17



CODIGO	MEDIDA	PRECIO
017000034	50 mm	
017000035	63 mm	
017000036	75 mm	
017000037	90 mm	
017000038	110 mm	
017000039	125 mm	
017000040	140 mm	
017000041	160 mm	
017000042	180 mm	
017000043	200 mm	
017000044	225 mm	
017000045	250 mm	
017000046	280 mm	
017000047	315 mm	
017000048	355 mm	
017000049	400 mm	
017000050	450 mm	
017000051	500 mm	
017000023	560 mm	
017000052	630 mm	



EMPAQUE PERFILADO ACERO/EPDM RD 11



CODIGO	MEDIDA	PRECIO
017000004	25 mm	
017000005	32 mm	
017000006	40 mm	
017000007	50 mm	
017000008	63 mm	
017000009	75 mm	
017000001	90 mm	
017000010	110 mm	
017000011	125 mm	
017000012	140 mm	
017000013	160 mm	
017000002	180 mm	
017000014	200 mm	
017000015	225 mm	
017000003	250 mm	
017000016	280 mm	
017000017	315 mm	
017000018	355 mm	
017000019	400 mm	
017000020	450 mm	
017000021	500 mm	
017000022	560 mm	
017000053	630 mm	



EMPAQUE PERFILADO FPM RD 11



CODIGO	MEDIDA	PRECIO
01700091	25 mm	
01700092	32 mm	
01700093	40 mm	
01700094	50 mm	
01700095	63 mm	
01700096	75 mm	
01700097	90 mm	
01700098	110 mm	
01700099	125 mm	
01700100	140 mm	
01700101	160 mm	
01700102	180 mm	
01700103	200 mm	
01700104	225 mm	
01700105	250 mm	
01700106	280 mm	
01700107	315 mm	
01700108	355 mm	
01700090	400 mm	

CÓDIGO
DESCUENTO

EMPAQUE PERFILADO ACERO/EPDM RD 33



CODIGO	MEDIDA	PRECIO
01700025	110 mm	
01700024	125 mm	
01700026	140 mm	
01700027	160 mm	
01700028	180 mm	
01700029	200 mm	
01700030	225 mm	
01700031	250 mm	
01700032	280 mm	
01700033	315 mm	

CÓDIGO
DESCUENTO

EMPAQUE PERFILADO FPM RD 17



CODIGO	MEDIDA	PRECIO
01700076	63 mm	
01700077	75 mm	
01700078	90 mm	
01700079	110 mm	
01700080	125 mm	
01700081	140 mm	
01700082	160 mm	
01700083	180 mm	
01700084	200 mm	
01700085	225 mm	
01700086	250 mm	
01700087	280 mm	
01700088	315 mm	
01700089	355 mm	
01700128	400 mm	

CÓDIGO
DESCUENTO

ESPACIADOR PARA ABRAZADERA



CODIGO	MEDIDA	PRECIO
02380014	16 mm	
02380015	20 mm	
02380016	25 mm	
02380017	32 mm	
02380018	40 mm	
02380019	50 mm	
02380020	63 mm	
02380021	75 mm	
02380022	90 mm	
02380023	110 mm	
02380024	125 mm	
02380025	140 mm	
02380026	160 mm	

CÓDIGO
DESCUENTO

EMPAQUE PERFILADO FPM, SOLDADURA SOCKET



CODIGO	MEDIDA	PRECIO
017000129	16 mm	
017000109	20 mm	
017000110	25 mm	
017000111	32 mm	
017000112	40 mm	
017000113	50 mm	
017000114	63 mm	
017000115	75 mm	
017000116	90 mm	
017000117	110 mm	

CÓDIGO
DESCUENTO

EMPAQUES PARA BRIDA (BAJO TORQUE)



EPDM, ANSI B16.5

CÓDIGO	MEDIDA	PRECIO
3113005	1/2"	
3113007	3/4"	
3113010	1"	
3113012	1 1/4"	
3113015	1 1/2"	
3113020	2"	
3113025	2 1/2"	
3113030	3"	
3113040	4"	
3113060	6"	
3113080	8"	
3113100	10"	
3113120	12"	

CÓDIGO
DESCUENTO

EMPAQUE PERFILADO EPDM, SOLDADURA SOCKET



CODIGO	MEDIDA	PRECIO
017000118	16 mm	
017000119	20 mm	
017000120	25 mm	
017000121	32 mm	
017000122	40 mm	
017000123	50 mm	
017000124	63 mm	
017000125	75 mm	
017000126	90 mm	
017000127	110 mm	

CÓDIGO
DESCUENTO

EMPAQUES PARA BRIDA (BAJO TORQUE)



EPDM CUBIERTO DE PVDF

CÓDIGO	MEDIDA	PRECIO
3115005	1/2"	
3115007	3/4"	
3115010	1"	
3115015	1 1/2"	
3115020	2"	
3115030	3"	
3115040	4"	
3115060	6"	
3115080	8"	
3115100	10"	

ABRAZADERAS PP



CODIGO	MEDIDA	PRECIO
023800001	16 mm	
023800002	20 mm	
023800003	25 mm	
023800004	32 mm	

EMPAQUES PARA BRIDA (BAJO TORQUE)



EPDM CUBIERTO DE PTFE

CÓDIGO	MEDIDA	PRECIO
3114005	1/2"	
3114007	3/4"	
3114010	1"	
3114012	1 1/4"	
3114015	1 1/2"	
3114020	2"	
3114025	2 1/2"	
3114030	3"	
3114040	4"	
3114060	6"	
3114080	8"	
3114100	10"	
3114120	12"	

ABRAZADERAS PP CON OPRESOR



CODIGO	MEDIDA	PRECIO
023800005	40 mm	
023800006	50 mm	
023800007	63 mm	
023800008	75 mm	
023800009	90 mm	
023800010	110 mm	
023800011	125 mm	
023800012	140 mm	
023800013	160 mm	

EQUIPOS TERMOFUSION



VENTA

SHOP 4 MINIPLAST PARA FUSION A TOPE DE 110V



CODIGO	MEDIDA	PRECIO
5730000	20-110MM	

SHOP 12 W25000 PARA FUSION A TOPE DE 110V



CODIGO	MEDIDA	PRECIO
5722000	50-315 MM	

RENTA

SHOP 4 MINIPLAST PARA FUSION A TOPE DE 110V



CODIGO	PRECIO
9730000-2	SEMANAL
9730000-3	MENSUAL

SHOP 12 W25000 PARA FUSION A TOPE DE 110V



CODIGO	PRECIO
9722000-2	SEMANAL
9722000-3	MENSUAL

PARA RENTA SE DEBE FIRMAR CONTRATO
RENTA DIARIA, COTIZAR POR EVENTO

ACCESORIOS



CORTADOR MANUAL DE TUBERÍA



CODIGO	MEDIDA	PRECIO
790109001	16-63MM	
790109002	50-110MM	
790109003	110-160MM	

RUEDA DE REPUESTO



CODIGO	MEDIDA	PRECIO
790109011	16-63MM	
790109012	50-110MM	
790109013	110-160MM	



Fundada en 1975, y dedicada a la comercialización y distribución de sistemas de tubería, EMMSA se ha consolidado como uno de los distribuidores mayoristas más importantes a nivel nacional.

EMMSA le ofrece soluciones para mercados muy importantes como Industria, Plomería, Eléctrico, Obras Municipales, Riego Residencial y Golf, además de Riego Agrícola.

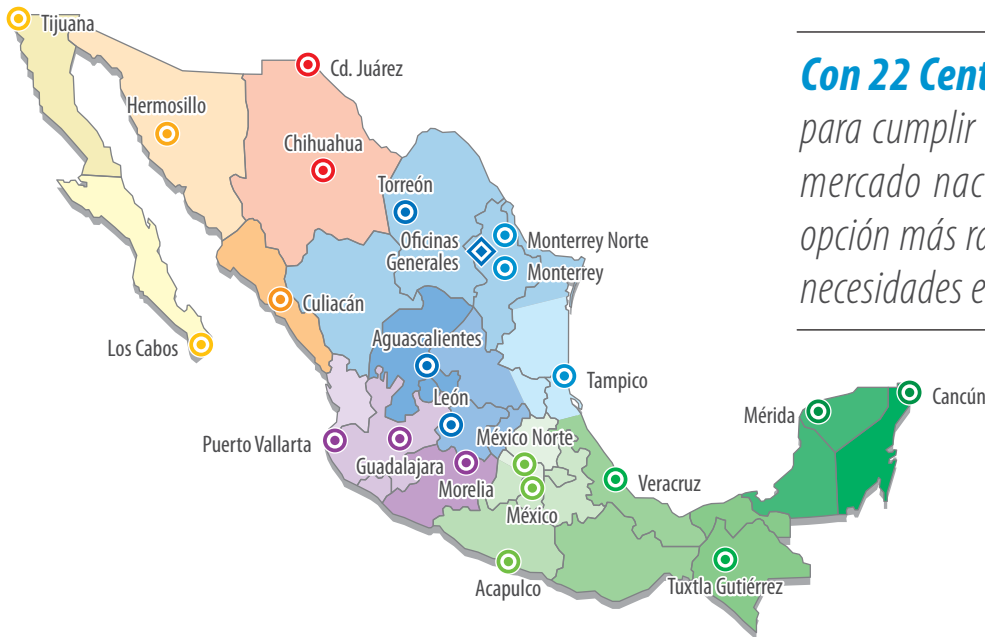

Con 22 Centros Regionales de Distribución para cumplir con la demanda de productos que el mercado nacional requiere, EMMSA le ofrece la opción más rápida y eficiente para cubrir todas las necesidades en sistemas de tubería.

Contáctenos además en internet:
www.emmsa.com.mx

OFICINAS GENERALES

Priv. San Ignacio No. 105
Col. Santa María, Monterrey, N.L., 64650
Tel. (81) 8153-0010
Fax: (81) 8153-0005
dir@emmsa.com.mx

CENTRO REGIONAL MONTERREY

Aarón Sáenz No. 1804-2
Col. Santa María, Monterrey, N.L., 64650
Tel. (81) 8865-3500
Fax: (81) 8335-5224
mtym@emmsa.com.mx

CENTRO REGIONAL GUADALAJARA

Av. Oleoducto No. 2820
Fracc. Alamo Industrial, Guadalajara, Jal., 44490
Tel. (33) 3540-8800
Fax: (33) 3540-8819
guad@emmsa.com.mx

CENTRO REGIONAL MÉXICO

Leyes de Reforma No. 111, Paseos de Churubusco
Deleg. Iztapalapa, México, D.F., 09030
Tel. (55) 9171-7000
Fax: (55) 9171-7010
mexico@emmsa.com.mx

CENTRO REGIONAL LEÓN

Camino a Conalep No. 101-1
Fracc. Ciudad Industrial, León, Gto., 37490
Tel. (477) 152-4150 al 59
Fax: (477) 152-4152 y 53
leon@emmsa.com.mx

CENTRO REGIONAL HERMOSILLO

Bldv. Francisco Zamora esq. Blvd. Luz Valencia
Miniparque Industrial, Hermosillo, Son., 83118
Tel. (662) 289-9500
Fax: (662) 289-9507
hsillo@emmsa.com.mx

CENTRO REGIONAL MÉRIDA

60 Diagonal No. 511 Int. 1 cruz con 63
Parque Industrial Yucatán, Mérida, Yuc., 97300
Tel. (999) 941-2150, 941-2151, 941-2109
Fax: (999) 941-2150
merida@emmsa.com.mx

CENTRO REGIONAL CD. JUÁREZ

Av. Tecnológico No. 5956
Col. Ampliación Aeropuerto
Cd. Juárez, Chih., 32550
Tel. / Fax: (656) 619-4039, 619-6030
juarez@emmsa.com.mx

CENTRO REGIONAL VERACRUZ

Calle Laurel S/N Lotes 38 Manzana 19
Col. Cd. Ind. Bruno Pagliai, Veracruz, Ver., 91697
Tel. (229) 920-8564, 920-9212, 920-9217
Fax: (229) 920-8564, 920-9212
veracruz@emmsa.com.mx

CENTRO REGIONAL TIJUANA

Libramiento Ote. No. 124-A
Parque Industrial Morelos, Tijuana, B.C.N., 22640
Tel. (664) 700-5775, 700-5792
Fax: (664) 700-5775, 700-5792
tijuana@emmsa.com.mx

CENTRO REGIONAL CULIACÁN

Prolongación Calle Primera No. 2660
Col. ISSSTESIN, Culiacán, Sin., 80026
Tel. (667) 750-4576, 750-4577
Fax: (667) 750-4576, 750-4577
culiacan@emmsa.com.mx

CENTRO REGIONAL CANCÚN

Supermanzana 301, Mz. 55 Lote 55
Parque Ind. Santa Ana, Cancún, Q. Roo, 77536
Tel. / Fax: (998) 843-6160, 886-3150
Tel. / Fax: (998) 843-6219
cancun@emmsa.com.mx

CENTRO REGIONAL LOS CABOS

Calle Flor de Pitahaya S/N
Col. Brisas del Pacífico, Cabo San Lucas, BCS., 23410
Tel. (624) 146-4112, 146-4114
Fax: (624) 146-4112, 146-4114
loscabos@emmsa.com.mx

CENTRO REGIONAL MÉXICO NORTE

Av. Gustavo Baz No. 166-B Int. 3
Col. La Escuela, Tlalneapantla, Edo. de México, 54090
Tel. (55) 5020-7920
Fax: (55) 5020-7920
mexiconorte@emmsa.com.mx

CENTRO REGIONAL TAMPICO

Perimetral Duport No. 1201 esquina Calle C-2A
Fracc. Comercial Fimex, Altamira, Tamps., 89603
Tel. (833) 123-0320, 123-0368, 123-0334
Fax: (833) 123-0320
tampico@emmsa.com.mx

CENTRO REGIONAL MORELIA

Privada Sur 1 No. 70
Col. Cd. Industrial, 3er. Etapa, Morelia, Mich., 58200
Tel. (443) 204-1066, 204-1065
Fax: (443) 204-1066
morelia@emmsa.com.mx

CENTRO REGIONAL AGUASCALIENTES

Aguascalientes Norte No. 151-1
Parque Industrial del Valle de Aguascalientes
Aguascalientes, Ags., 20300
Tel. / Fax: (449) 922-9933 al 36
aguascalientes@emmsa.com.mx

CENTRO REGIONAL MONTERREY NORTE

Av. Los Ángeles No. 3400, entre Churubusco y
Antonio I. Villarreal, Col. Coyoacán, Monterrey, N.L., 64510
Tel. (81) 8215-9013 al 15
Fax: (81) 8215-9017
mtynorte@emmsa.com.mx

CENTRO REGIONAL CHIHUAHUA

Calle Industrial Diez No. 7404 esq. Calle Ind. Juárez
Col. Industrial Robinson, Chihuahua, Chih., 31074
Tel. (614) 420-5670, 420-5524
Fax: (614) 420-5670, 420-5524
chihuahua@emmsa.com.mx

CENTRO REGIONAL ACAPULCO

Av. Ejido No. 82
Col. Hogar Moderno, Acapulco de Juárez, Gro., 39580
Tel. (744) 483-2294, 483-2354
Fax: (744) 483-2294, 483-2354
acapulco@emmsa.com.mx

CENTRO REGIONAL TUXTLA GUTIÉRREZ

Carr. Tuxtla Gutiérrez-San Fernando Km. 5.5 S/N
Col. Plan de Ayala, Tuxtla Gutiérrez, Chis., 29110
Tel. (961) 140-3143, 140-3144
Fax: (961) 140-3143, 140-3144
tuxtla@emmsa.com.mx

CENTRO REGIONAL PUERTO VALLARTA

Carr. Las Juntas-Ixtapa No. 421 Int. 6 y 7
Col. Las Juntas, Puerto Vallarta, Jal., 48291
Tel. (322) 290-0855, 290-3929, 290-3913
Fax: (322) 290-0855, 290-3929, 290-3913
puertovallarta@emmsa.com.mx

CENTRO REGIONAL TORREÓN

Adolfo Aymes No. 192
Col. Ciudad Industrial Torreón
Torreón, Coah., 27019
Tel. / Fax: (871) 750-7992
torreon@emmsa.com.mx